

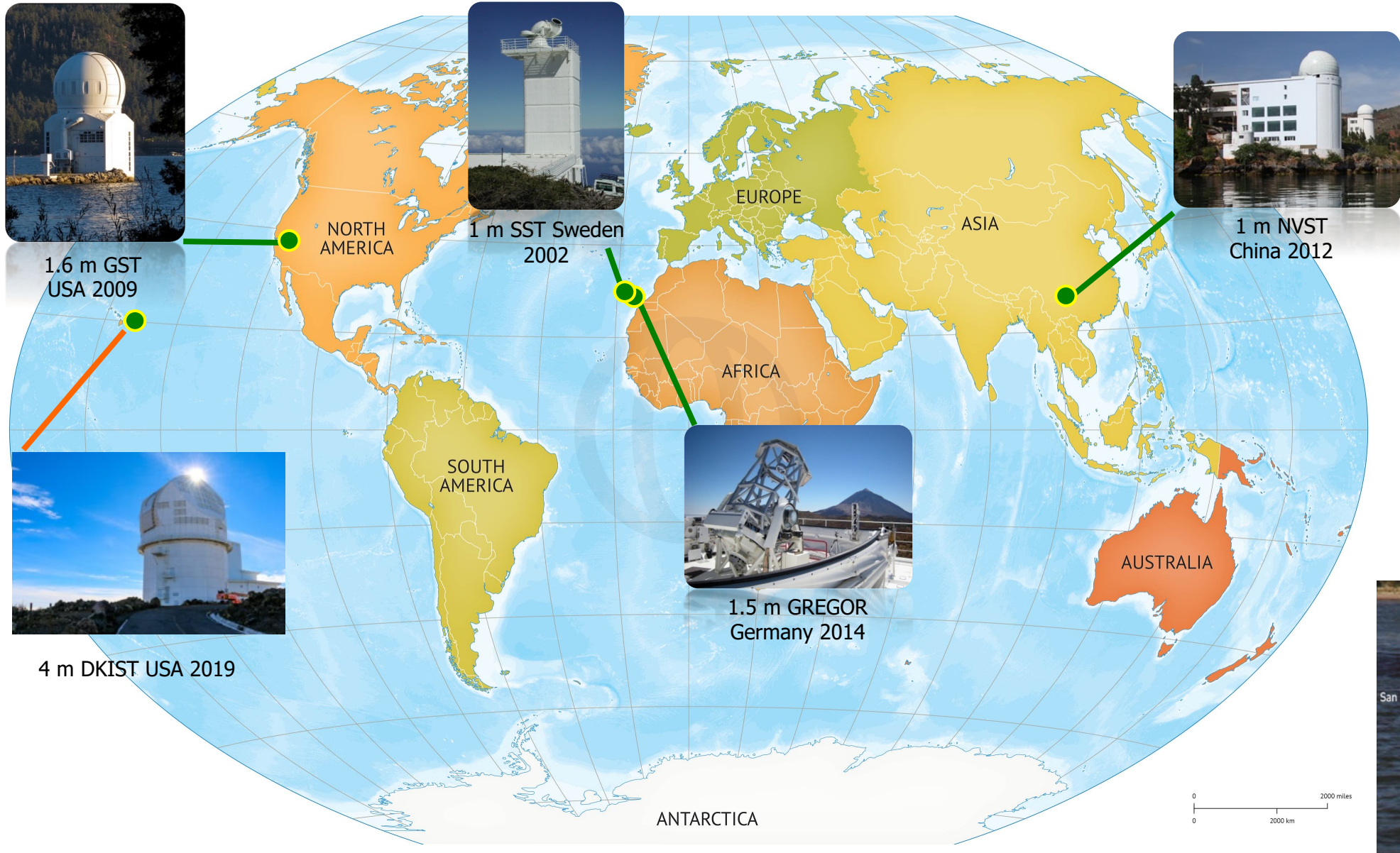

An Overview of Big Bear Solar Observatory

Wenda Cao

- ✧ Big Bear Solar Observatory (BBSO) of NJIT is a remote facility in California.
- ✧ BBSO now operates one of the highest resolution solar telescope – the 1.6-meter off-axis Goode Solar Telescope (GST).
- ✧ The dome sits at the end of a 1,000-foot causeway on Big Bear Lake's north shore at 6,750-foot elevation.
- ✧ The surrounding waters of Big Bear Lake reduce ground level convection and provide superb conditions for solar observing.
- ✧ GST opens its observing time and data to the Solar Physics and Space Science Communities.



1 m NVST
China 2012



1 m SST Sweden
2002

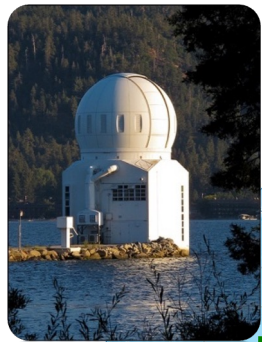

1.6 m GST
USA 2009

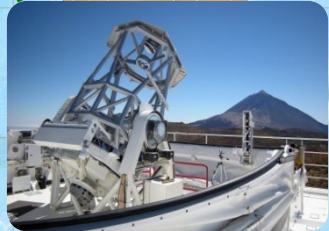

1.5 m GREGOR
Germany 2014



4 m DKIST USA 2019

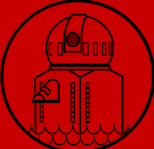

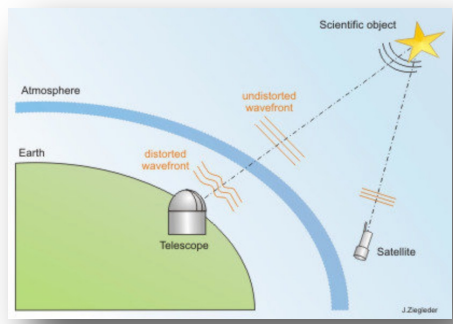

Turbulence in Earth's Atmosphere

- ❖ Turbulence in earth's atmosphere makes astronomical targets twinkle.
- ❖ Turbulence changes rapidly with time.
- ❖ Temperature fluctuations in small patches of air cause changes in index of refraction.
- ❖ Atmospheric perturbations cause distorted wavefronts.
- ❖ When light rays reach telescope, they are no longer parallel, hence they can't be focused to a point.

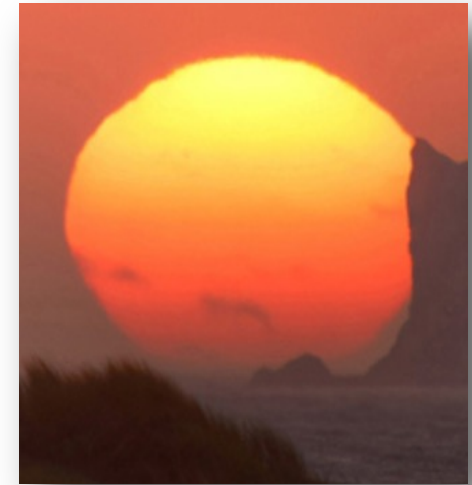

Characterize Turbulence Strength by r_0

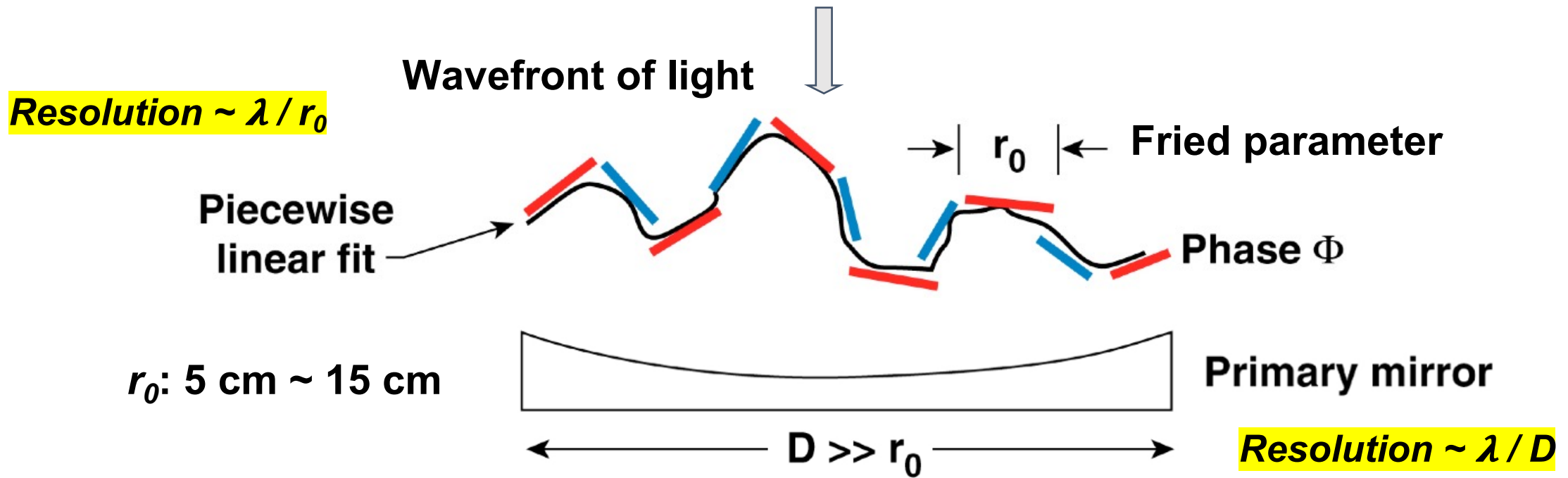

- ❖ "Coherence Length" from all atmosphere contribution and can be seen as an average turbulence cell size.
- ❖ r_0 is diameter of the circular pupil for which the diffraction limited image and the seeing limited image have the same angular resolution.
- ❖ Any telescope with diameter $D > r_0$ has no better spatial resolution than a telescope for which $D = r_0$

Seeing Characteristic r_0 at Big Bear

- ❖ Big Bear Lake reduce ground level convection, and predominant winds bring smooth air flows across the flat surface of the lake.
- ❖ Seeing character at Big Bear differs markedly from the high altitude, volcanic island sites measured in the DKIST site survey. The median r_0 for BBSO is shown in black (Hill et al. 2004).
- ❖ Observations using AO will be viable for extended periods during a typical day.
- ❖ Median $r_0 \sim 6$ cm @ 500 nm, and wind speed ~ 4 -6 m/s.

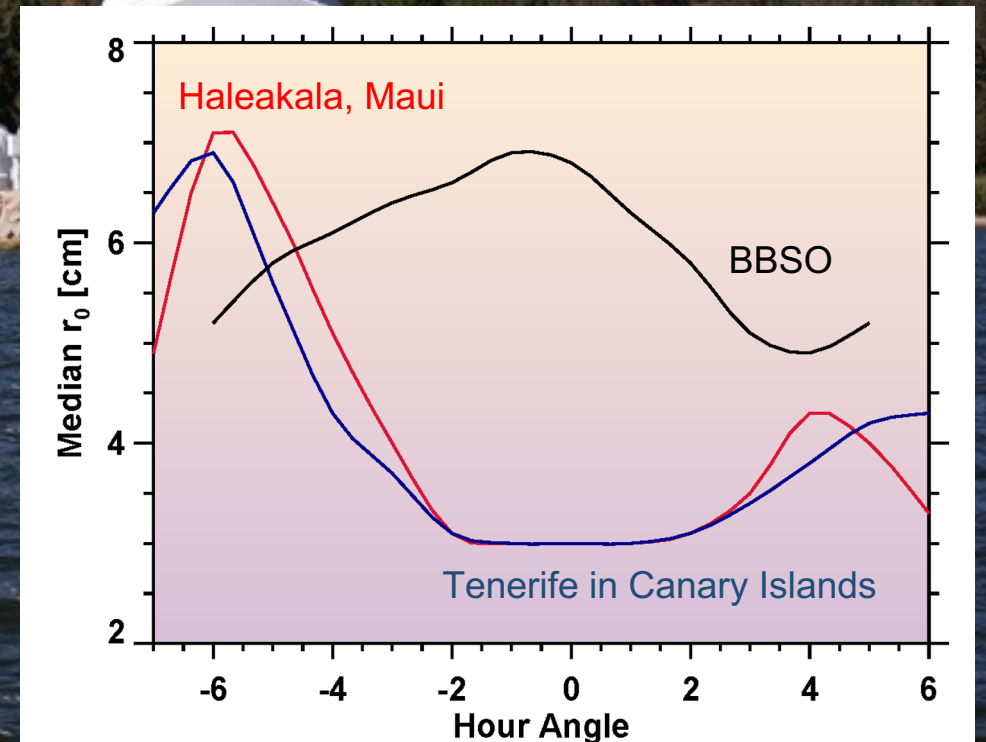



BBSO – History

- ❖ BBSO was constructed by Caltech in 1960s.
- ❖ Its 26-inch (65 cm) telescope advanced our understanding to our star in high resolution.
- ❖ In 1997, the first BBSO director, Prof. Zirin retired. Caltech decided to direct their resources to their nighttime astronomy program.
- ❖ New Jersey Institute of Technology (NJIT), in Newark, NJ took over the observatory operation.
- ❖ Prof. Phil Goode became the second director of BBSO.

Hedgerow Prominence



Sea Horse Flare on Aug. 7, 1972

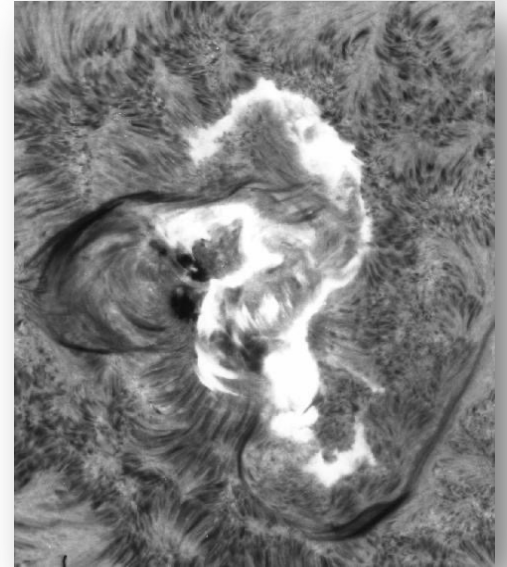



- GST presentation to NSF December 2002. Construction grants awarded.
- Fabrication of the primary mirror began 2003.
- Designs continued into 2005.
- DFM contracted for telescope structure 2005.
- Old dome removed October - November 2005.
- New dome built in December 2005 - January 2006.
- Dome drives installed March - June 2006.
- Mirror testing in last half of 2006, some problems with test procedures.
- Figuring and testing of mirror continued to June 2008.
- Old telescope removed in February 2007.
- New pier built in March-April 2007.
- Work deck (new observing floor) built April 2007.
- Dome drive rebuilt in 2008.
- Telescope structure built at DFM Engineering in January 2007 - September 2008.
- Final telescope assembly began in September 29, 2008.
- First light in January 19, 2009.
- Commissioning started in 2009 for one year.

NST Construction Milestones

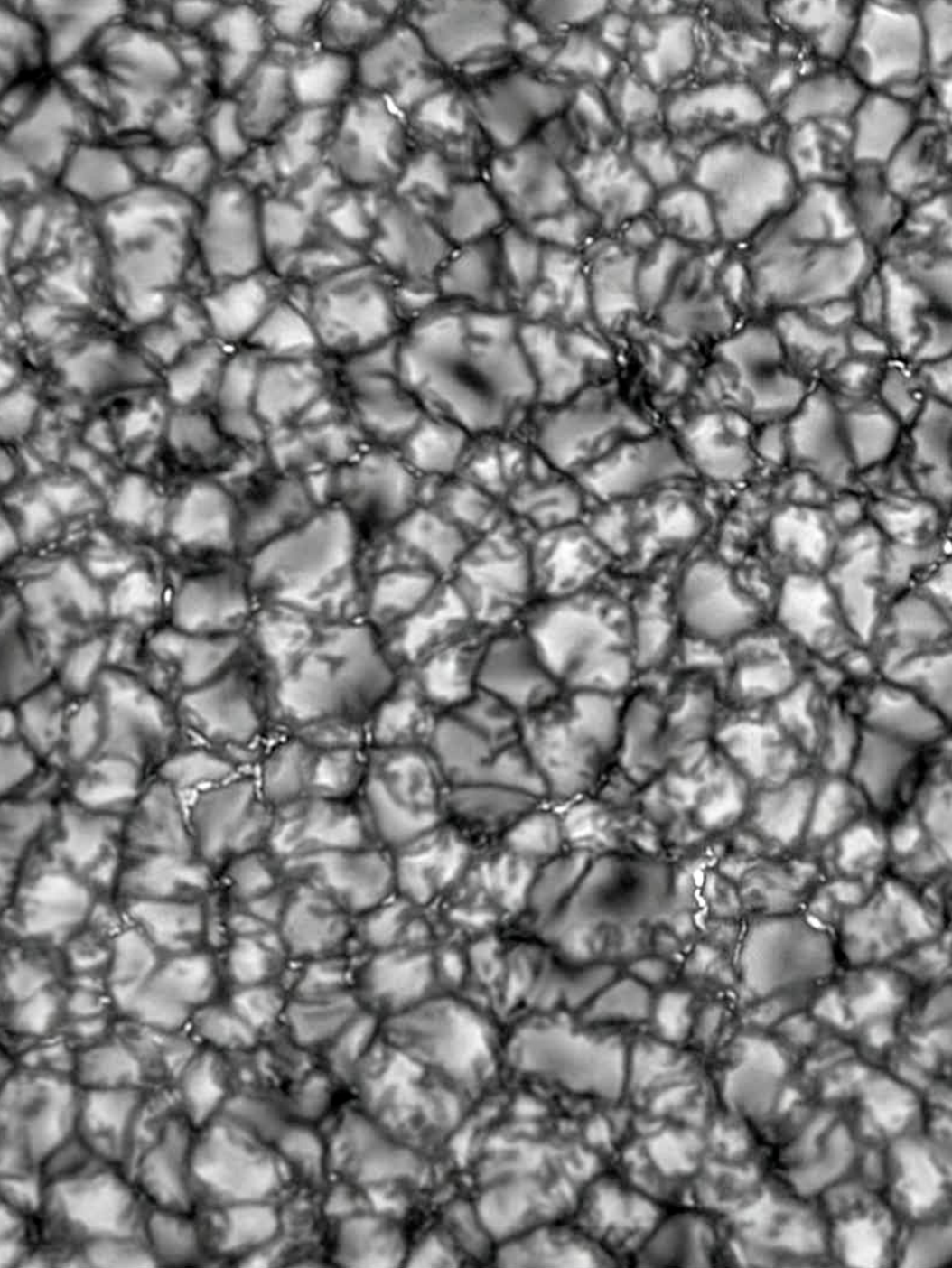

2010-08-03 17:06:08UT

2015-06-20T17:30:20

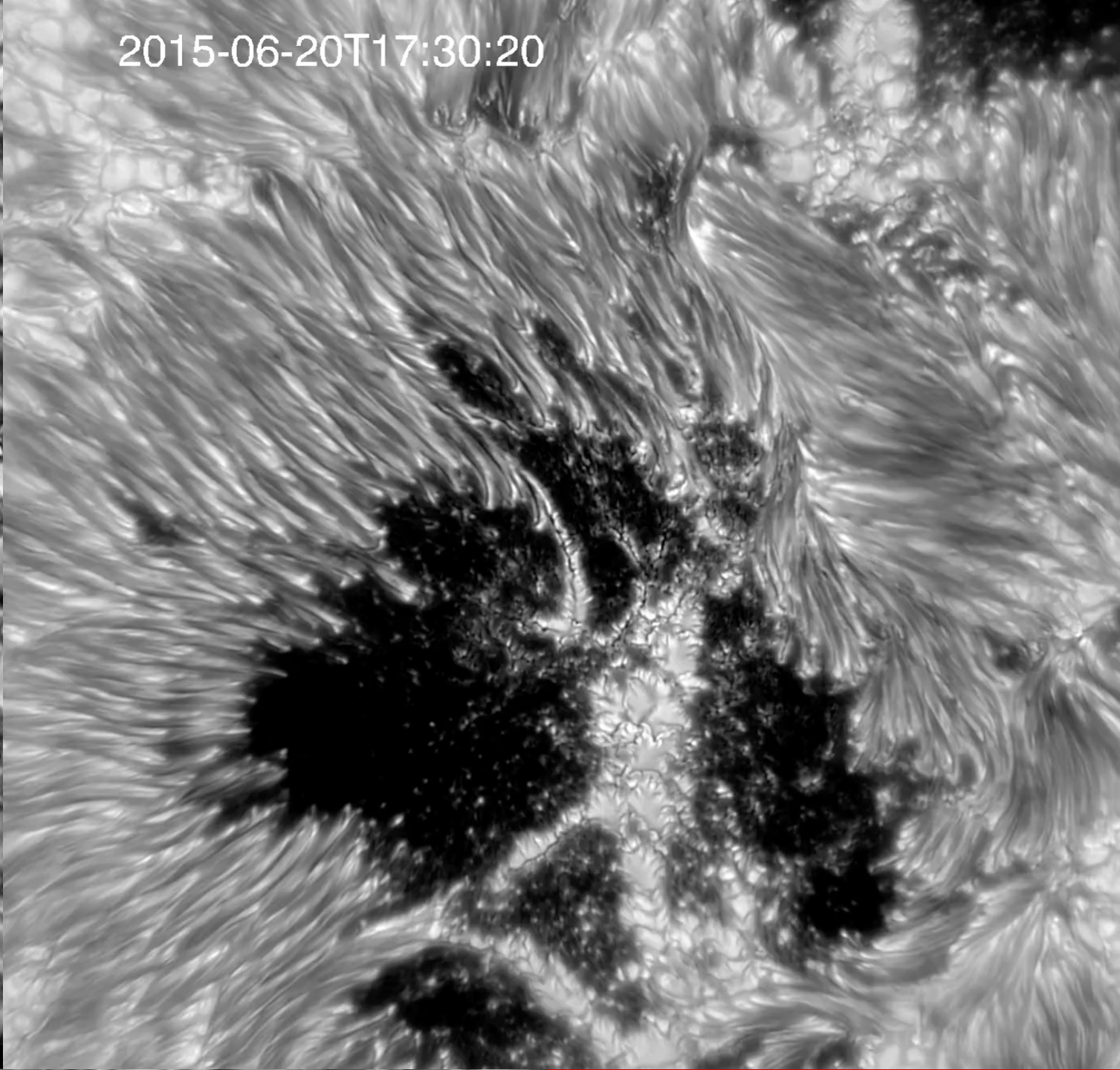

1.6 m Off-axis NST/GST

- ❖ The GST is an off-axis section of a 5.3-meter, $f/0.73$ Gregorian telescope. The result is an $f/2.4$, 1.7-meter system.
- ❖ The design offers an unobstructed pupil allowing superior adaptive optics (AO) performance and low scattered light.
- ❖ The prime focus, where most of the solar radiation must be absorbed, is accessible without obstructing the light path.
- ❖ A small (3.5 mm) field stop at prime focus limits the radiation loads transmitted to the downstream optics.

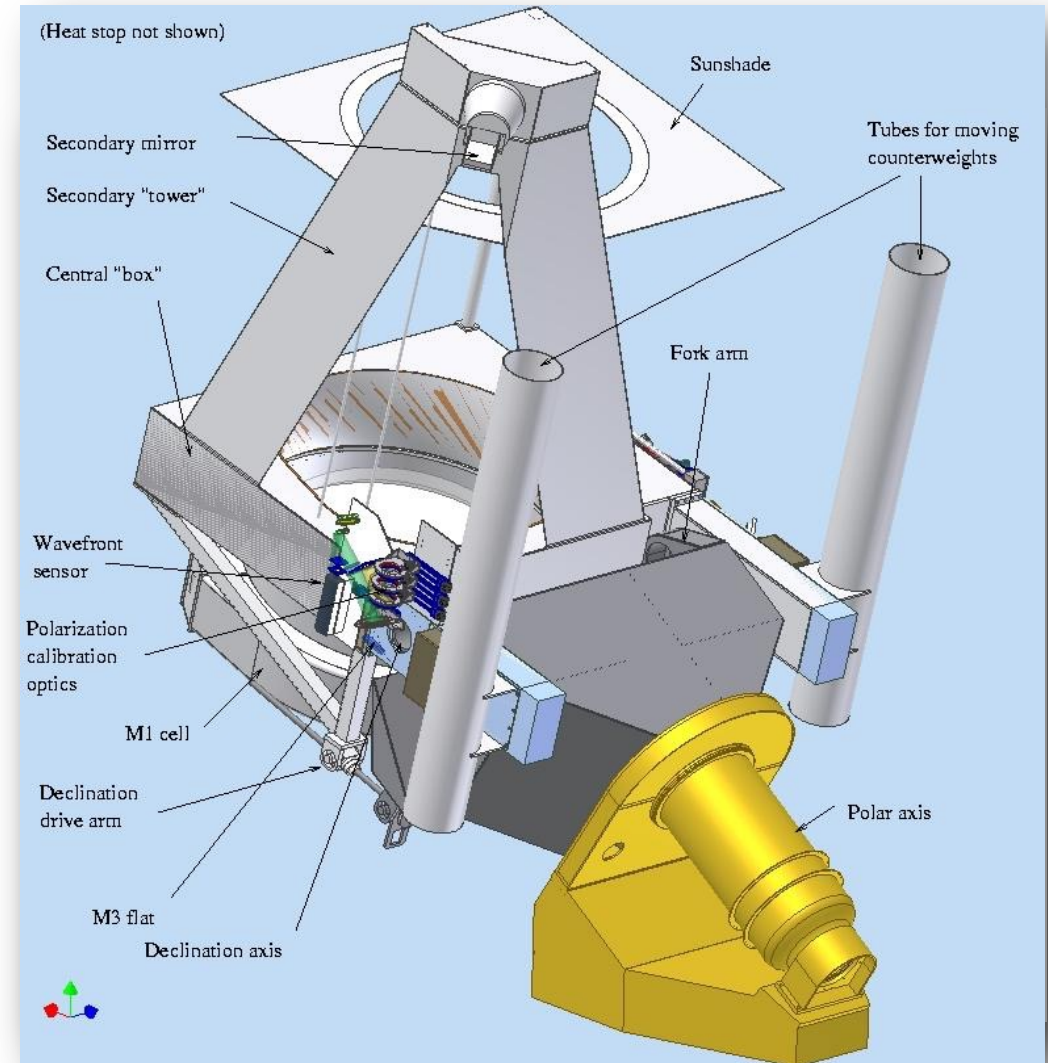

GST and its Scientific Instruments

- Adaptive Optics System (AO: AO-308, MCAO)
– SPIE.9148.100, SPIE.9148.193, SPIE.11448.1144924
- Visible Imaging Spectrometer (VIS)
– SPIE.9147.15, AN.331.636
- Near Infrared Imaging Spectro-polarimeter (NIRIS) – ASPC.463.291, SPIE.9147.127
- Fast Imaging Solar Spectrograph (FISS)
– Solar Phys.288.1
- Broad-band Filter Imager (BFI) – SPIE.7735.77355v
- Cryogenic Infrared Spectrograph (CYRA)
– SPIE.11447.11447AG, SPIE.9147.129
- NASA Mid-Infrared Imager (MIRI)

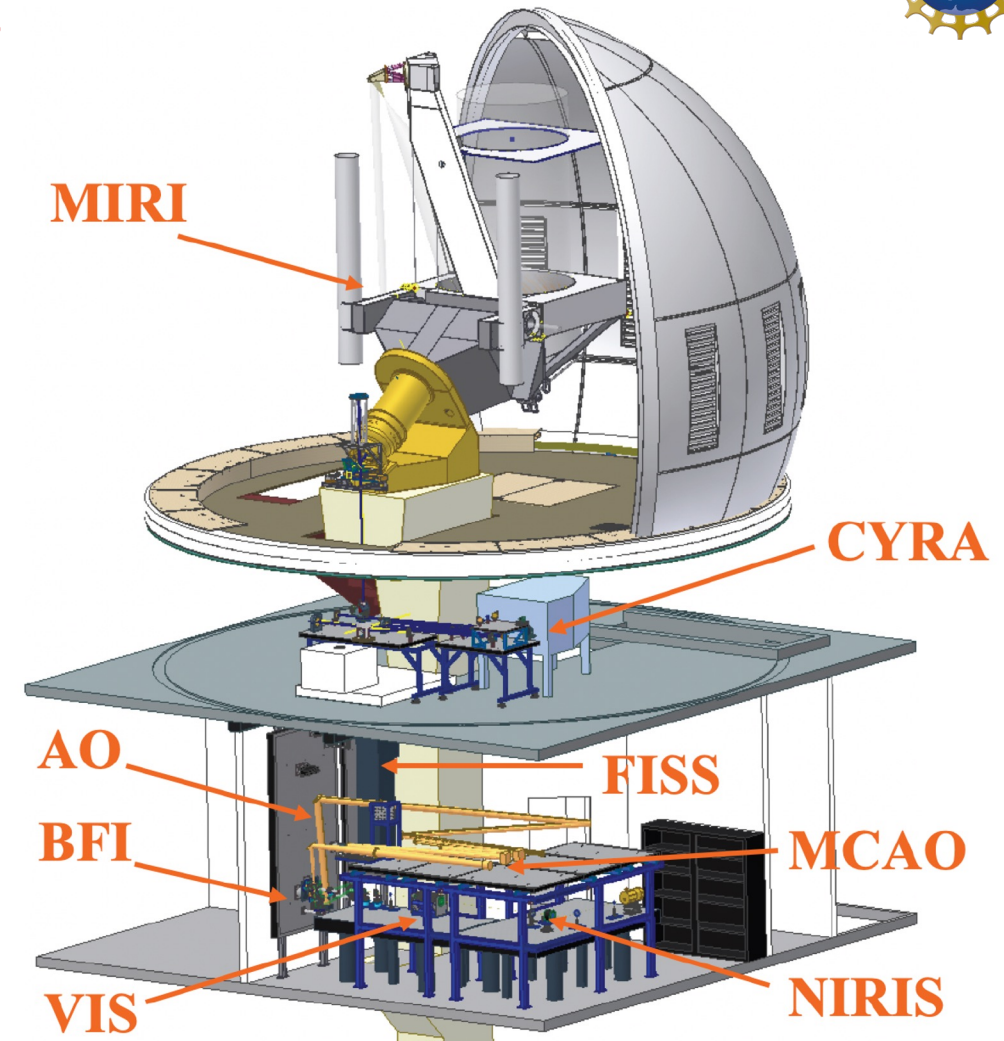

Adaptive Optics (AO) Principle

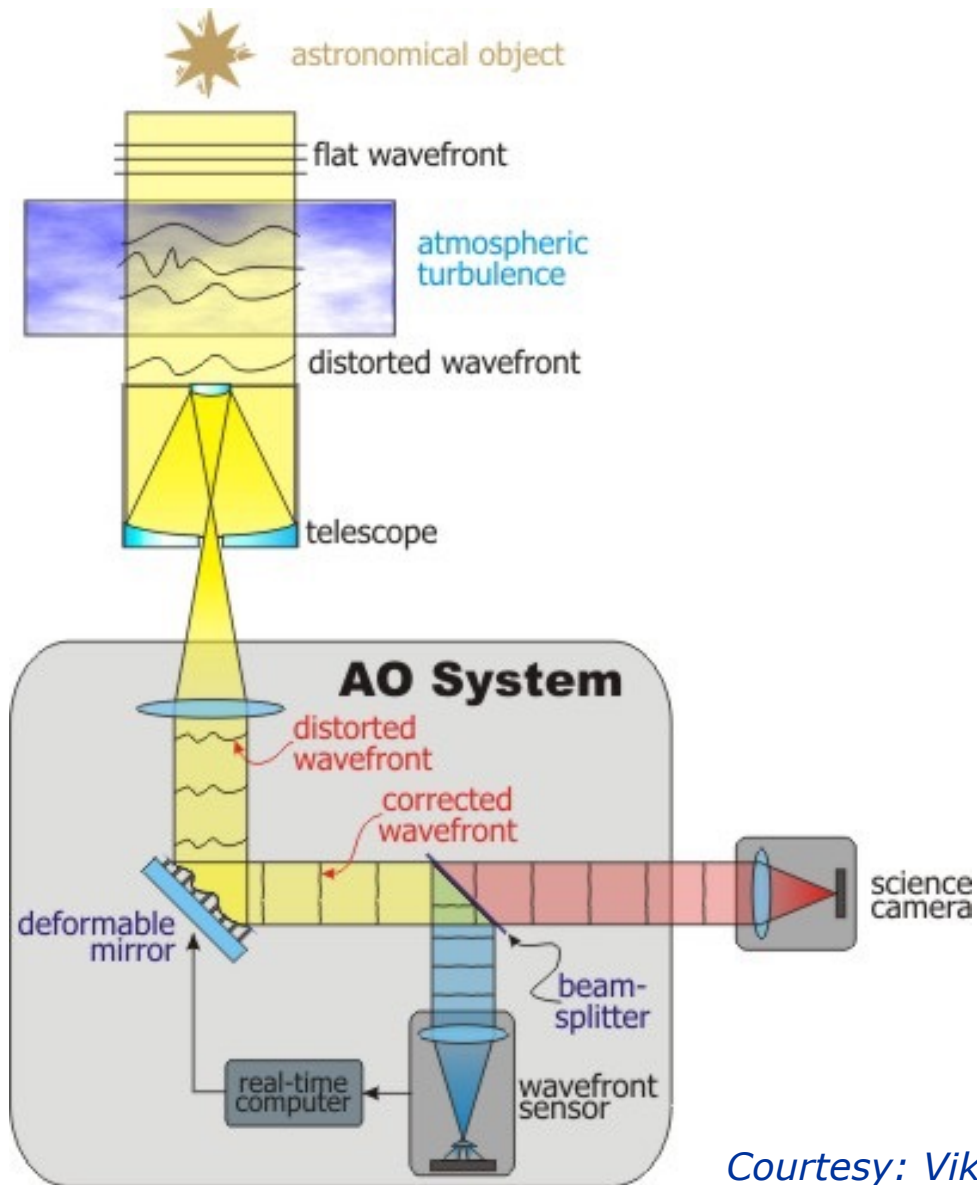

Courtesy: Vik Dhillon

- ❖ AO system uses a computer to control deformable mirror to correct for distortions caused by observing through the Earth's atmosphere.
- ❖ Wavefront sensor: measure details of blurring from the target you want to observe.
- ❖ Control system: calculate the shape to apply to deformable mirror to correct blurring.
- ❖ Deformable mirror: light from observing target is reflected from DM and distortions are removed.

GST AO and MCAO

- ❖ **1st Generation AO-76:** Strehl ratio: 0.7 in the NIR under median BBSO seeing.
- ❖ **2nd Generation AO-308:** Acquire diffraction limited imaging over the telescope's full range of operation.
- ❖ **3rd Generation GLAO & MCAO:** Expand field of view of diffraction limited observations to $\sim 1'$ in the visible.
- ❖ **Limb-AO** for observing solar prominences.
- ❖ **WFS Profiler** to measure seeing as a function of height in a real time.
- ❖ Successful collaboration between BBSO/NJIT, NSO and KIS.

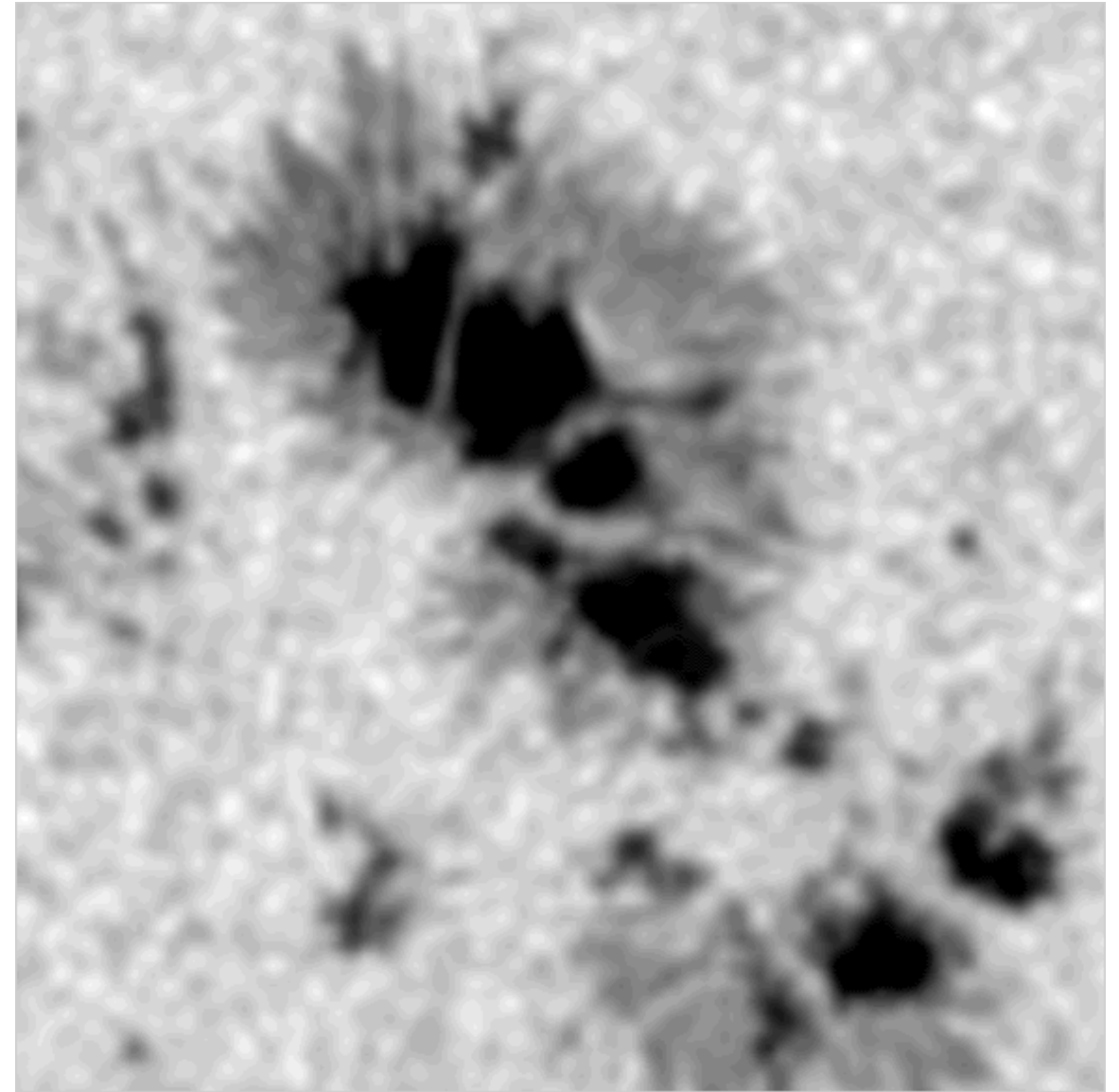

2nd Generation AO: AO-308

- ❖ AO-308 is operational, AO-308 is a collaboration between BBSO, NSO and KIS.
- ❖ Shack Hartmann WFS with 308 sub-apertures (AO-308): 20 sub-apertures across the GST primary mirror.
- ❖ Xinetics Deformable Mirror with 357 actuators and 5 mm spacing.
- ❖ Adimec camera with a frame rate of 1700 Hz for 400 by 400 pixels sub-array with a large full well.
- ❖ Using KAOS program with a high-performance computer.
- ❖ Closed-loop Bandwidth: 120 Hz.
- ❖ Adjustable number of corrected modes up to 285.
- ❖ Acquire diffraction limited imaging over the telescope's full range of operation.

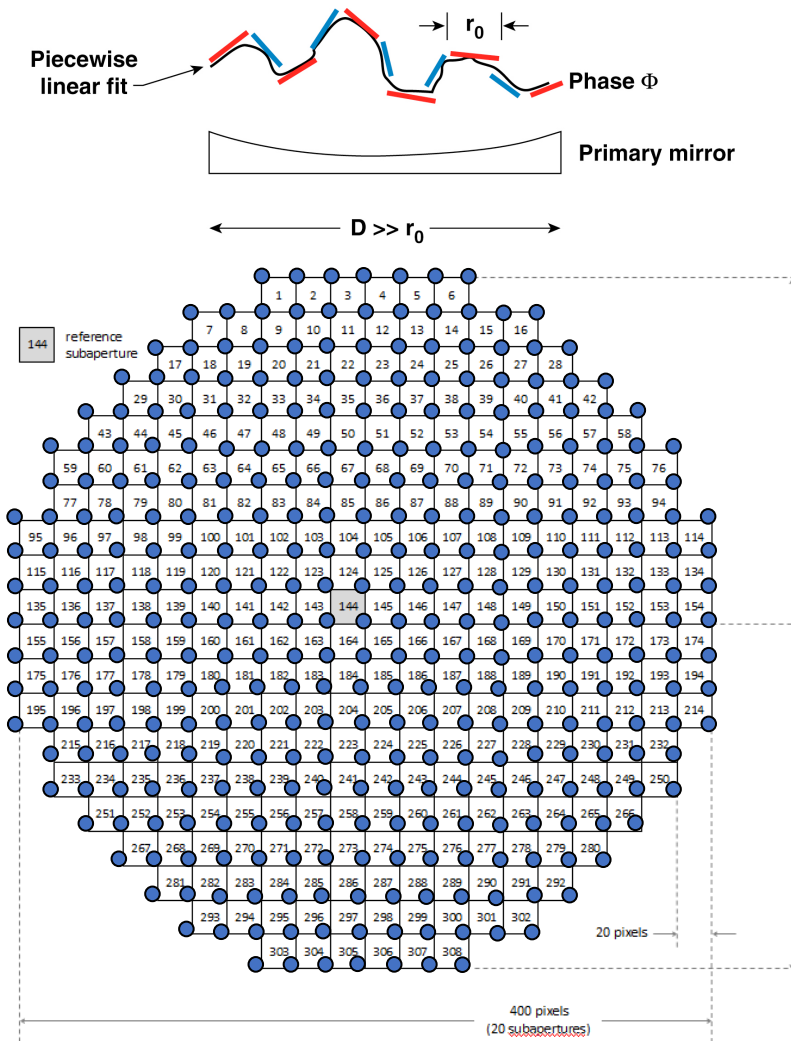

3rd Generation AO: MCAO

- ❖ Multi-Conjugate AO (MCAO) is a collaboration with BBSO, NSO and KIS.
- ❖ MD SH WFS with 208 sub-apertures and 9 guide regions.
- ❖ Three DMs with 357 actuators conjugated to pupil (1km), 3 km (2km), and 8 km (3km).
- ❖ Multi-CPU parallel computation.
- ❖ MichroTron high speed camera.
- ❖ Closed-loop Bandwidth: 120 Hz.
- ❖ One-click switch between MCAO, GLAO and CAO depending seeing conditions.
- ❖ Expand field of view of diffraction limited observations to $\sim 1'$ in the visible.

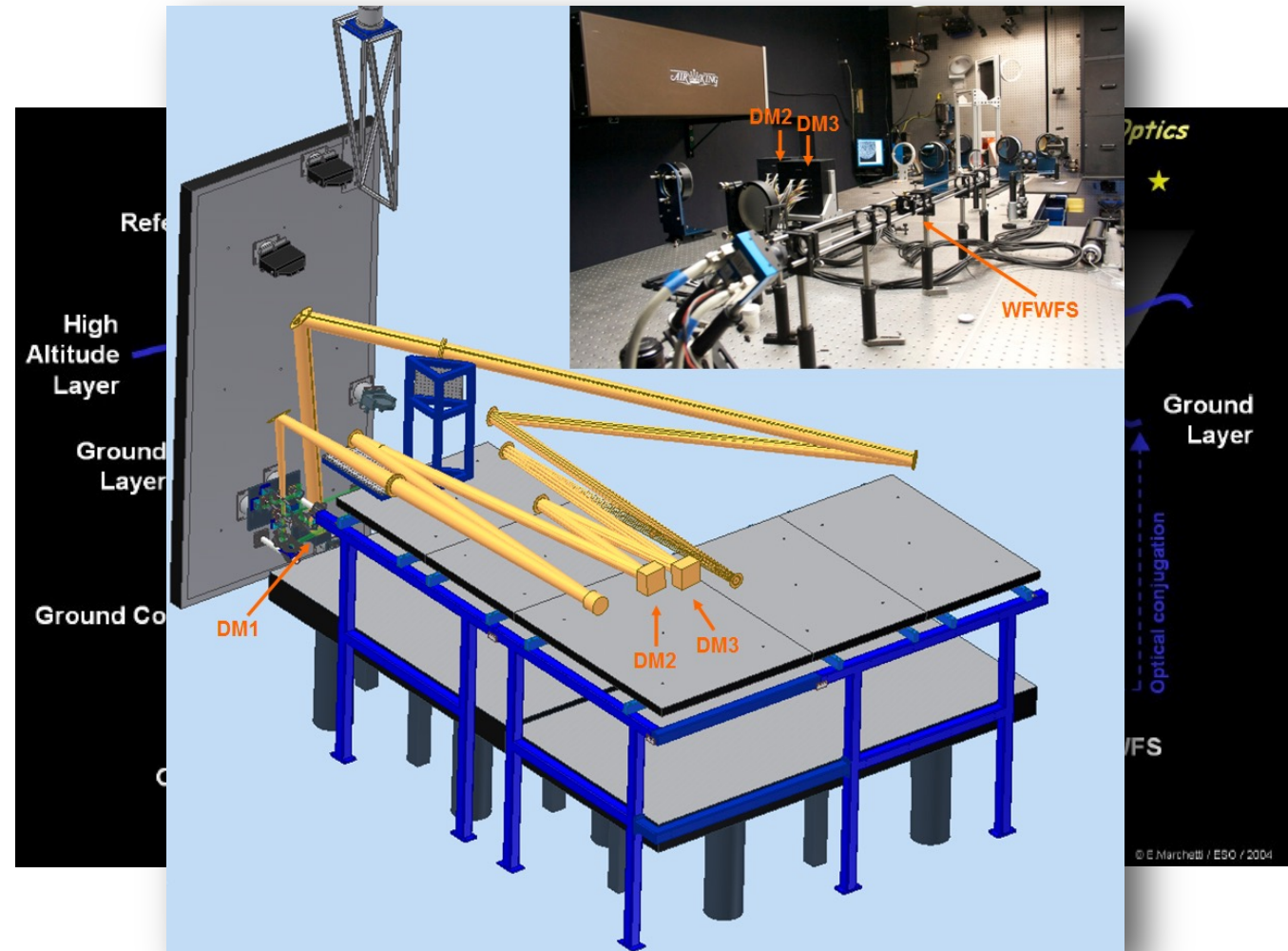



Limb AO

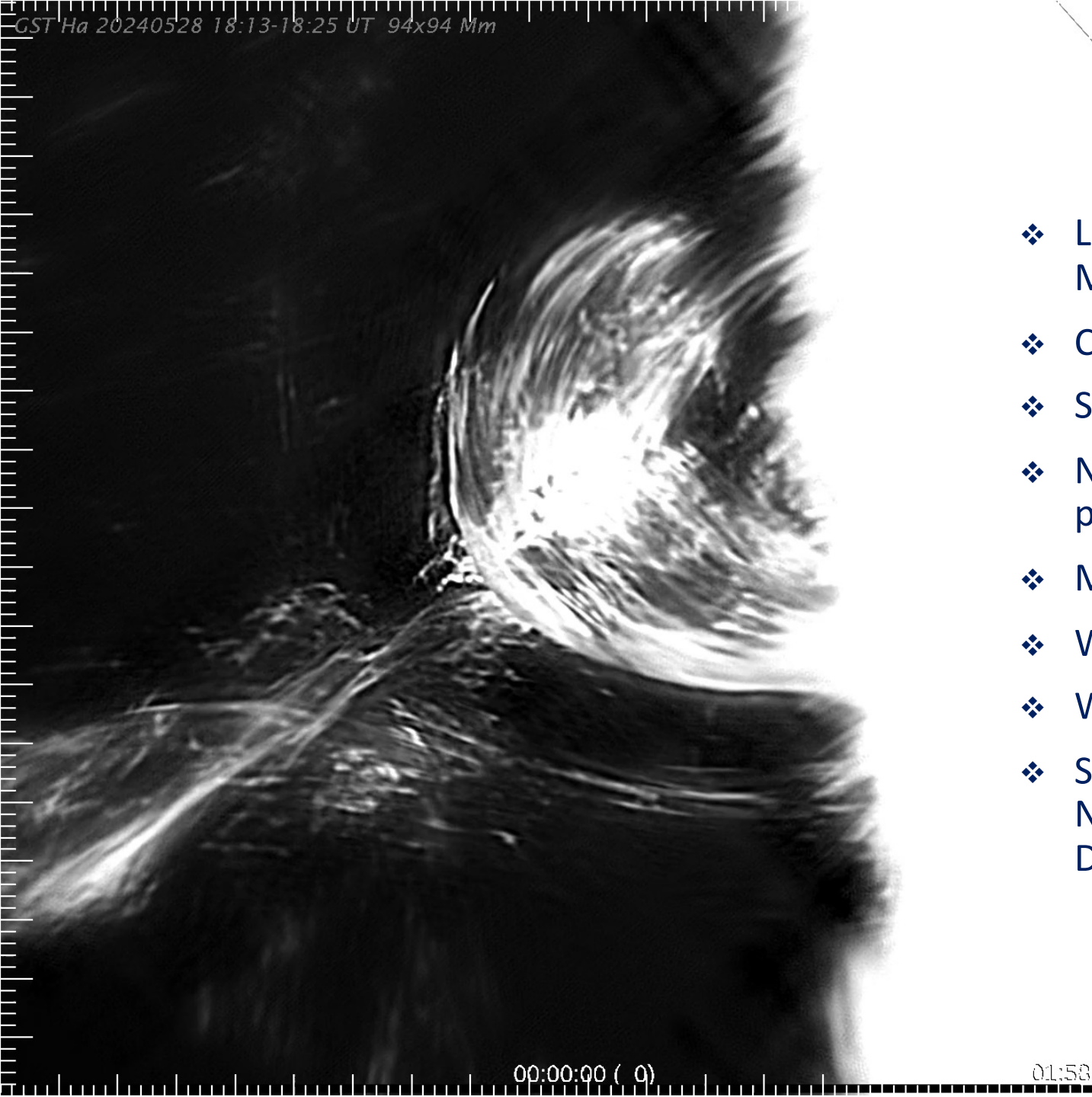

- ❖ Limb AO is a modified version of GST AO-308 Mk II for the prominence observations.
- ❖ Correlating Shack-Hartmann WFS.
- ❖ Sub-aperture size: [redacted]
- ❖ Number of sub-apertures: [redacted] across pupil).
- ❖ Maximum frame rate: [redacted]
- ❖ WFS Wavelength: [redacted]
- ❖ WFS field of view: [redacted]
- ❖ Successful collaboration between BBSO/NJIT, NSO and KIS, serving as the pathfinder for DKIST & EST.

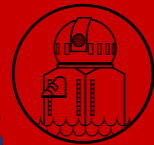

GST and its Scientific Instruments

- Adaptive Optics System (AO: AO-308, MCAO)
 - SPIE.9148.100, SPIE.9148.193, SPIE.11448.1144924
- Visible Imaging Spectrometer (VIS)
 - SPIE.9147.15, AN.331.636
- Near Infrared Imaging Spectro-polarimeter (NIRIS) – ASPC.463.291, SPIE.9147.127
- Fast Imaging Solar Spectrograph (FISS)
 - Solar Phys.288.1
- Broad-band Filter Imager (BFI) – SPIE.7735.77355v
- Cryogenic Infrared Spectrograph (CYRA)
 - SPIE.11447.11447AG, SPIE.9147.129
- NASA Mid-Infrared Imager (MIRI)

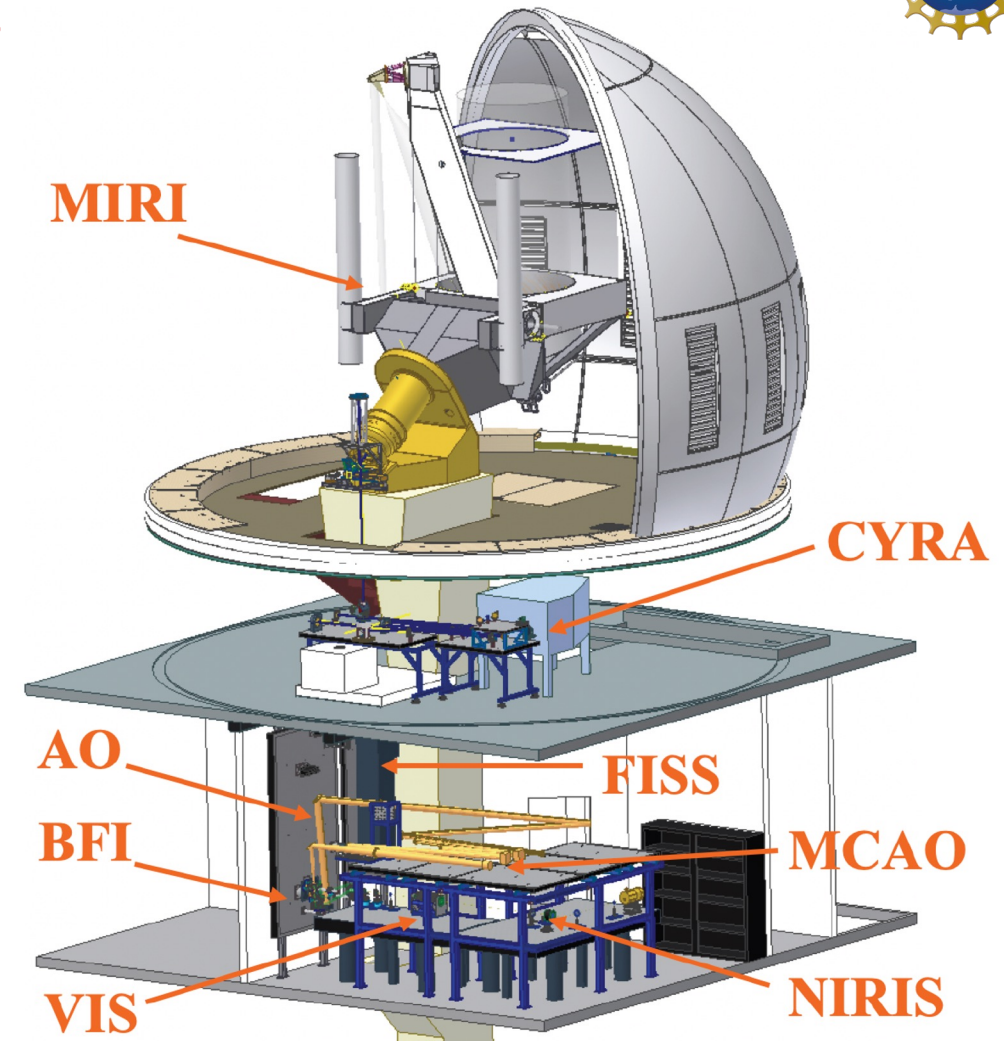

Imaging Spectroscopy

- ❖ Imaging spectroscopy can be defined as acquisition of images in hundreds of contiguous, registered, spectral band.
- ❖ Imaging spectroscopy generates a data cube with 3 dimensions: x , y , and λ .
- ❖ Unfortunately, instruments can only observe 2 simultaneously.
- ❖ Spectrograph observes x , λ at once and slit scan across y for imaging spectroscopy.
- ❖ Filter observes x , y and image scan over λ for imaging spectroscopy.
- ❖ Imaging spectro-polarimetry.

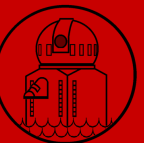
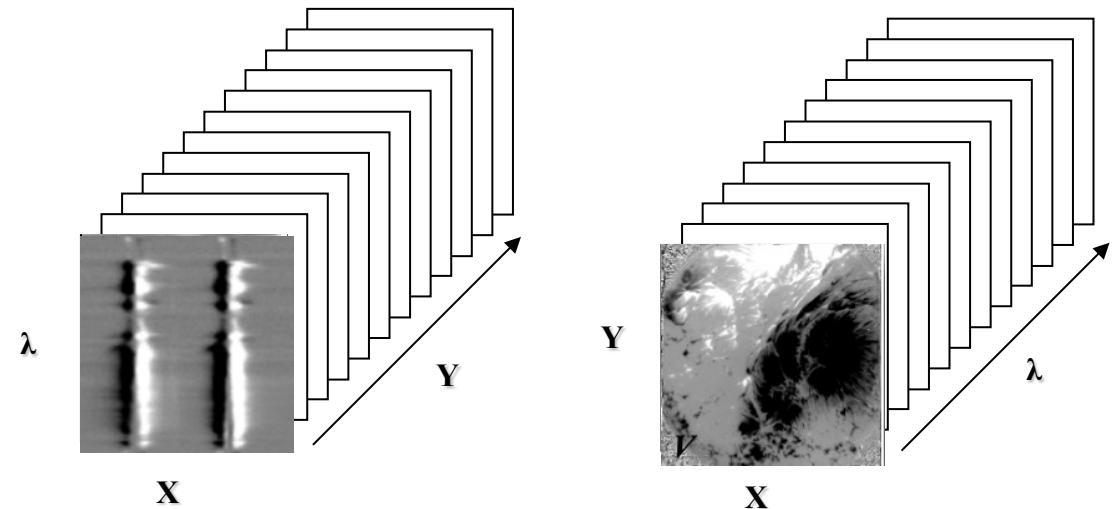
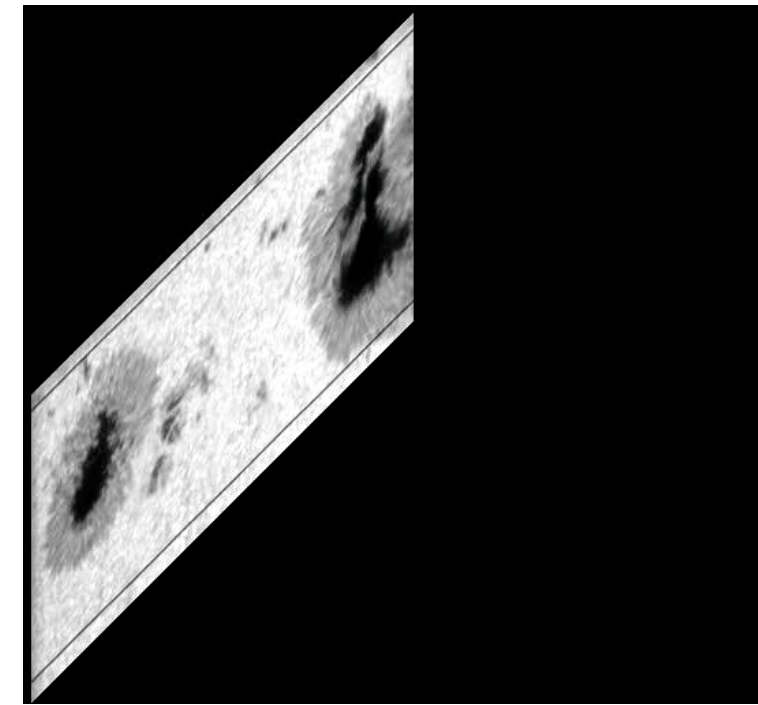

Broad-band Filter Imager - BFI

- ❖ Highest possible spatial and temporal resolution photospheric observations.
- ❖ Reference images for alignment with space instruments
- ❖ Typical exposure: 0.8 – 1.5 ms
- ❖ Typical burst cadence: 10 – 15 s.
- ❖ Available channels:

	Central Wavelength	Height above $\tau_{500}=1$	Filter Bandpass	Field of View	Image Scale	Minimum Cadence
G-band	430.5 nm	~ 50 km	5 Å	55"	0.027"/pix	7-10 secs
TiO	705.7 nm	~ 150 km	10 Å	70"	0.034"/pix	7-10 secs

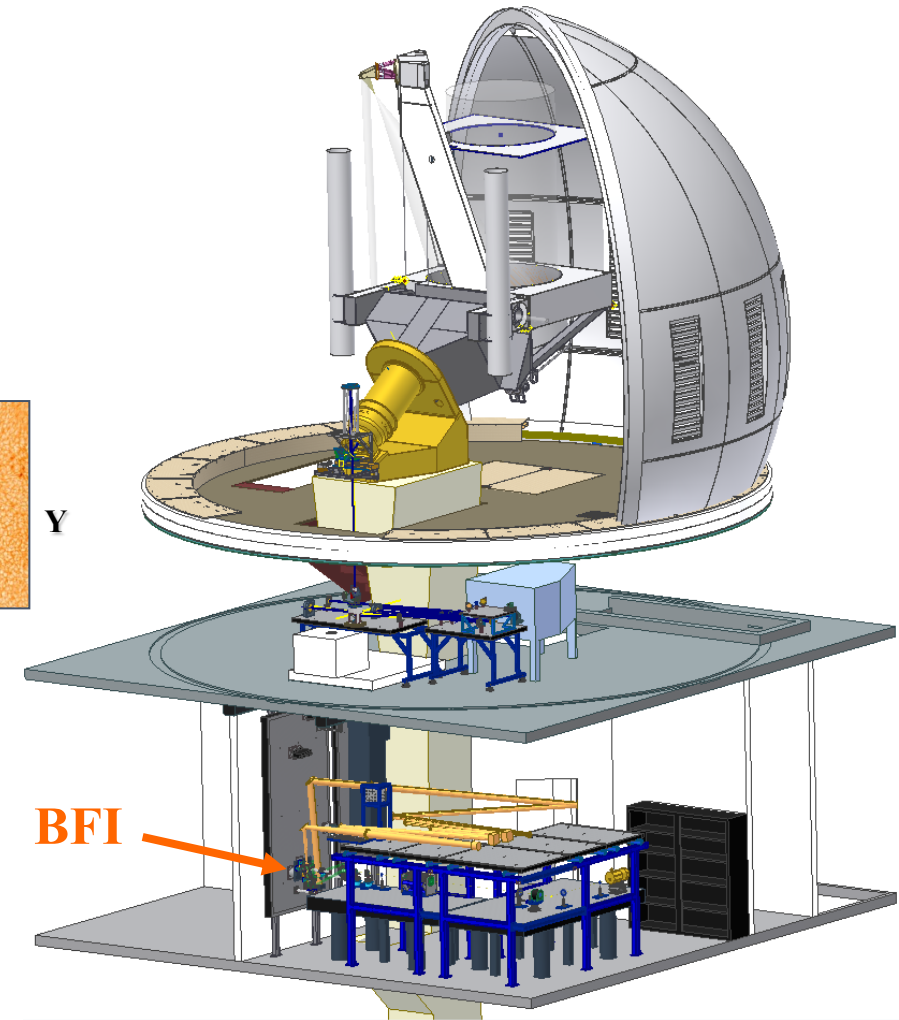
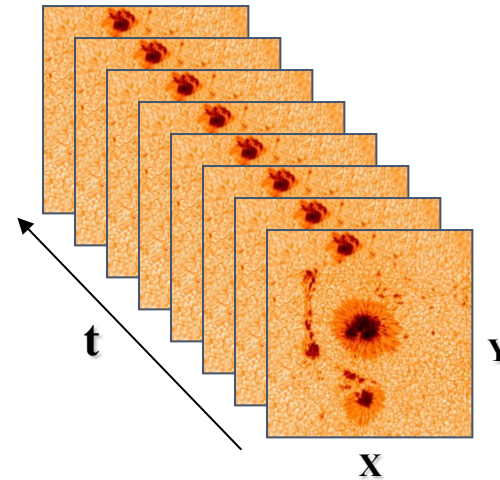

- ❖ Each burst is analyzed on the fly with 70 best contrast frames out of 100 images.
- ❖ All BFI bursts are processed with speckle interferometry to achieve the diffraction-limit.

Visible Imaging Spectrometer – VIS

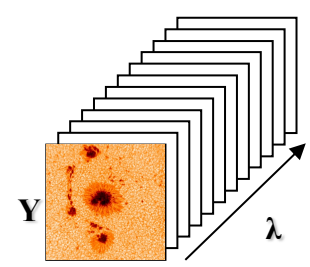

- ❖ High spatial resolution spectroscopy of the solar chromosphere with H α
- ❖ Narrow band tunable filter based on a single Fabry-Pérot etalon ($D = 70$ cm)
- ❖ Band pass: 5.8 – 8.2 pm
- ❖ Wavelength coverage: 550 – 700 nm
- ❖ Field of view (FOV): 75" by 64"
- ❖ Cadence ranges from 0.8 s (one to 25 s (13 positions)).
- ❖ Spatial resolution: $< 0.1''$ with AO and speckle reconstruction processing.

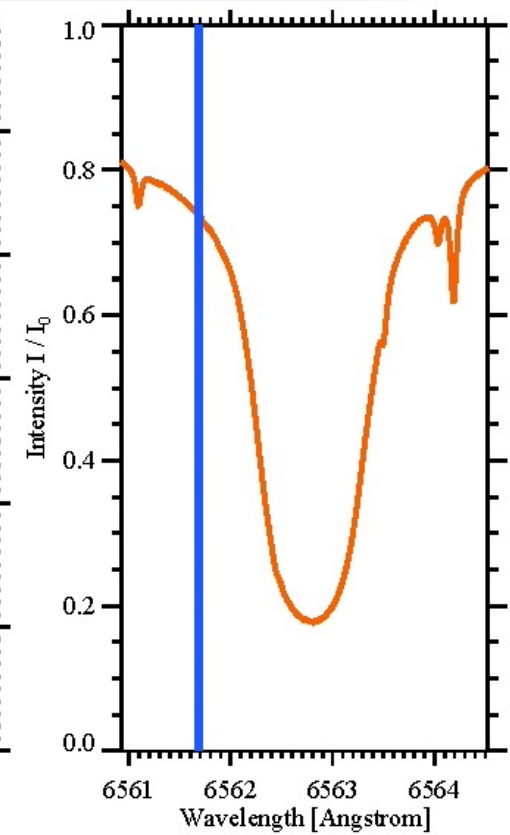
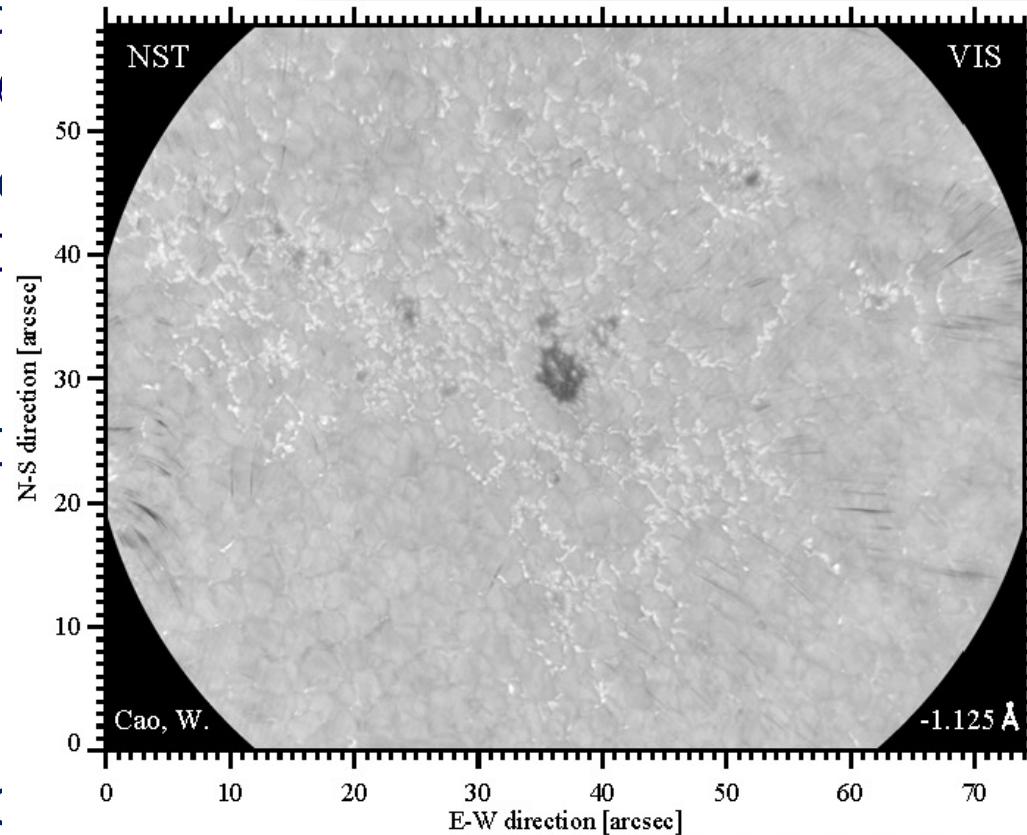

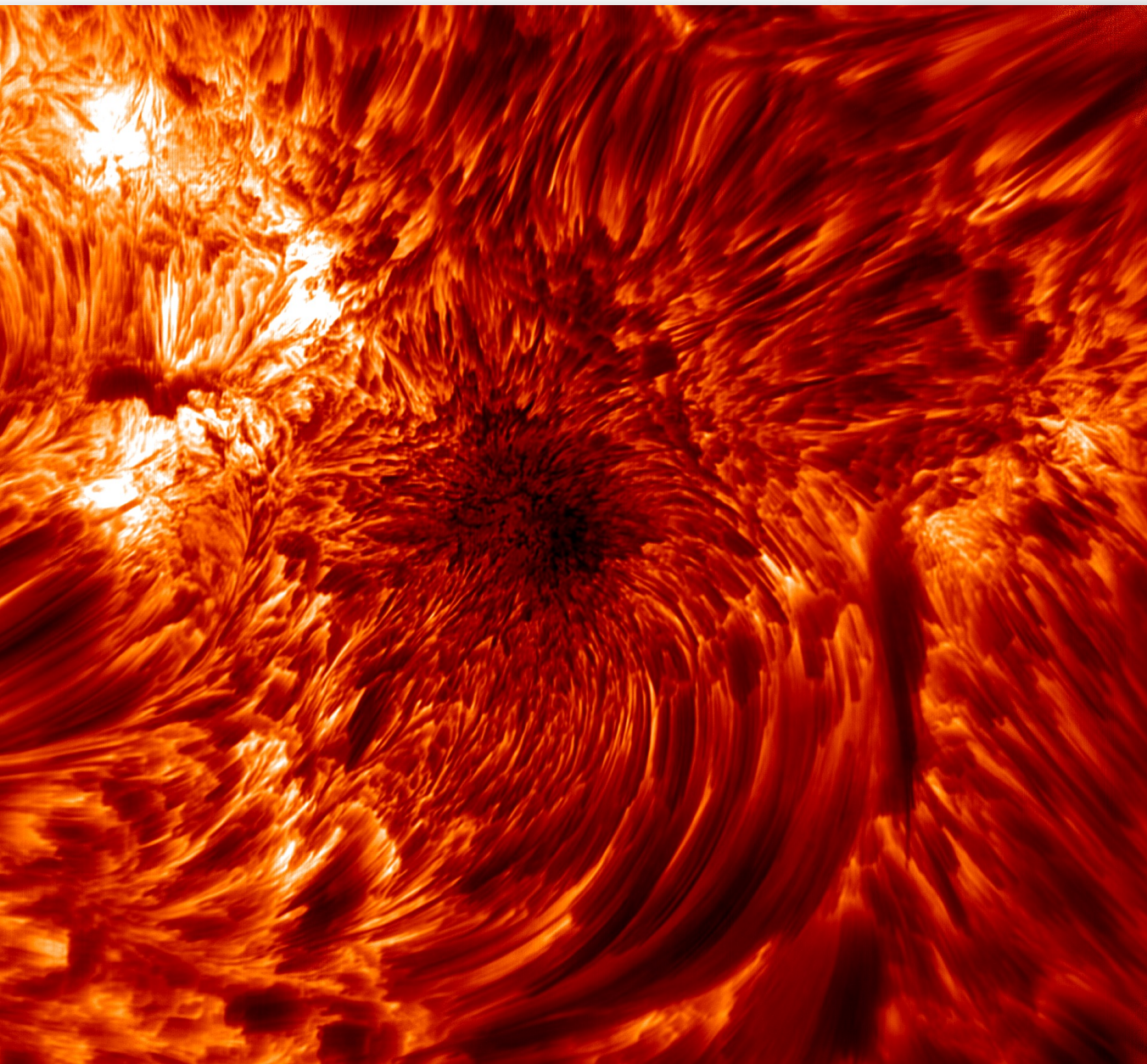

Wang, Cao, Liu, et al., *Nature Communications*, 6, 7008, 2015

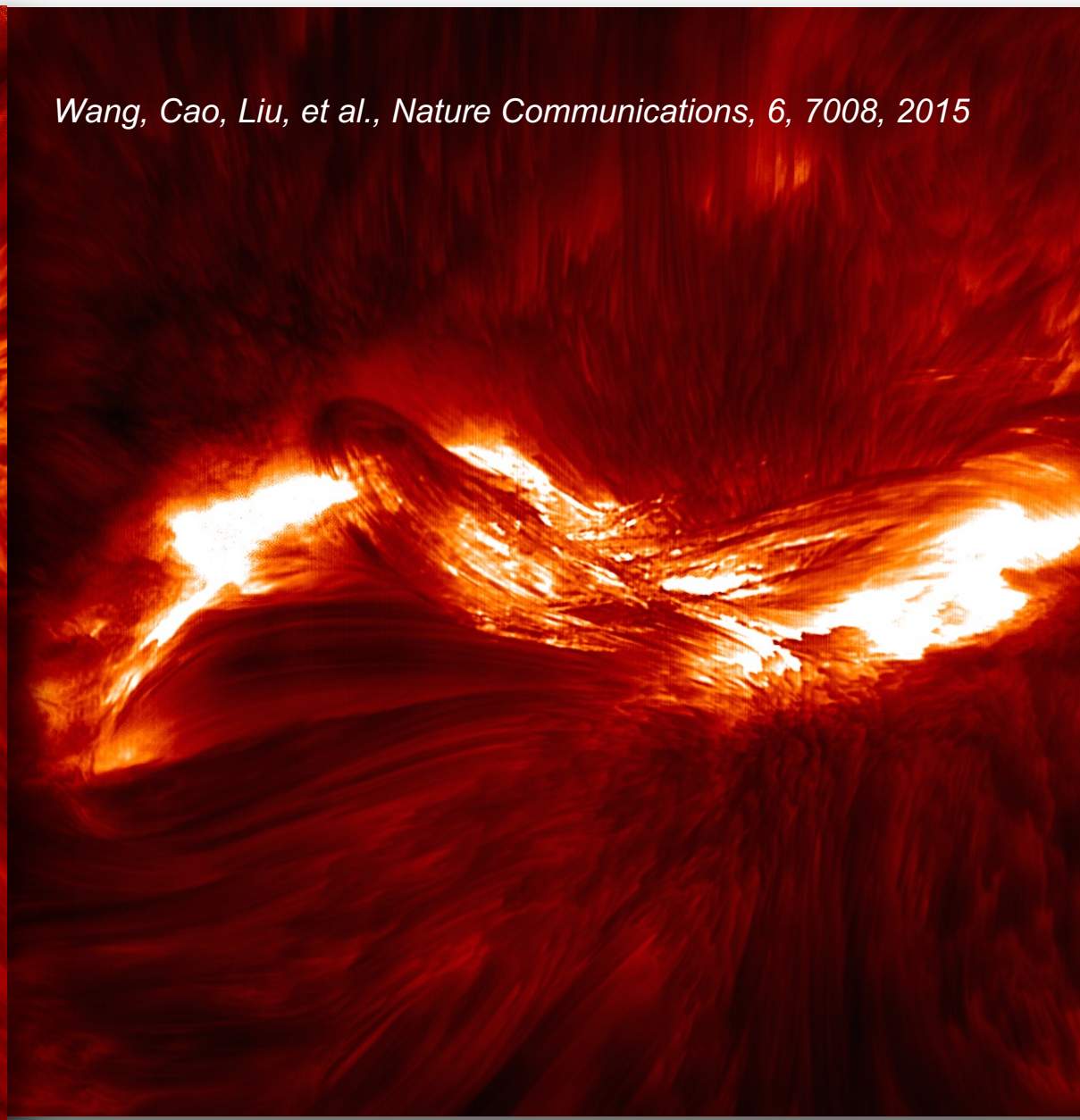

Upgrading Visible Imaging Spectrometer – VIS-II

- ❖ Replace the VIS with a dual FPIs system, each with a 100 mm aperture to cover a broader wavelength range in the visible and have a larger FOV and scanning range.
- ❖ Wavelength coverage: 480 – 860 nm.
 - Ha 656.3 nm – chromosphere dynamics
 - He I 587.6 nm – D3 – flares
 - Fe I 617.3 nm – photospheric magnetic fields
 - Ca II 854.2 nm – chromospheric magnetic fields
 - 543.5 nm or 769.9 nm
- ❖ FOV – TBD: 85" by 85".
- ❖ Scanning range > 0.15 nm @ Ha line
- ❖ Spatial resolution: < 0.1" with AO and speckle reconstruction processing.

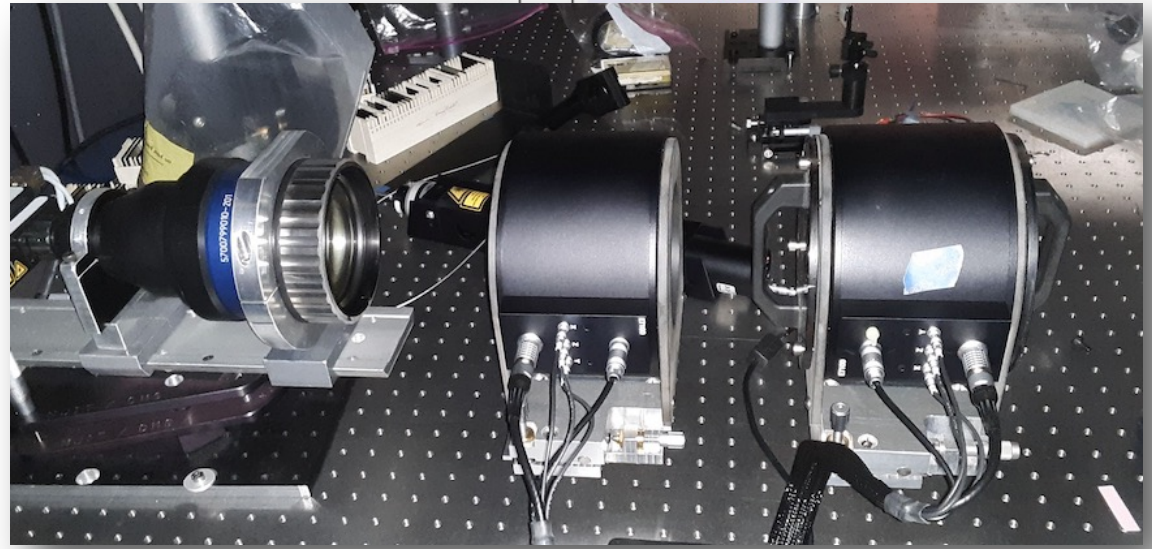
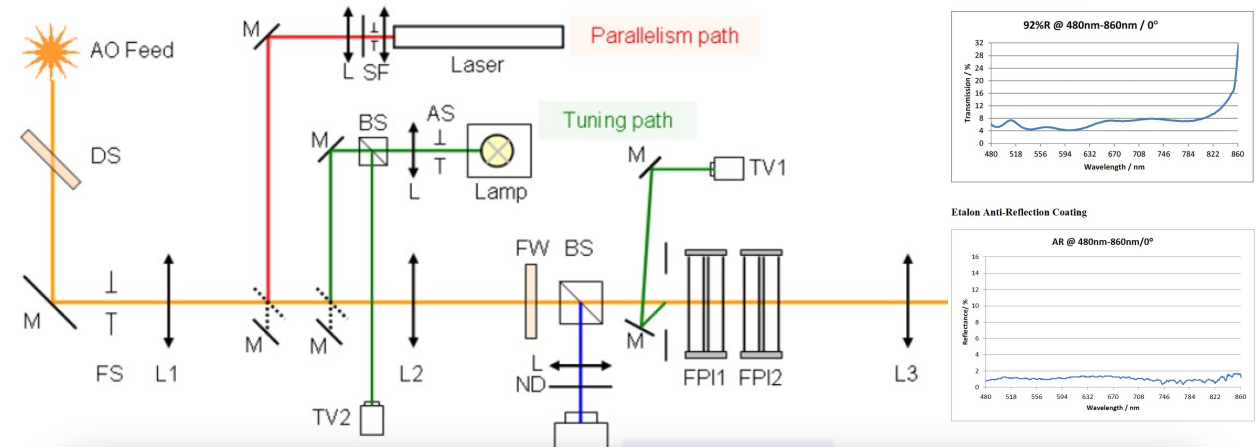

Near Infrared Imaging Spectro-polarimeter - NIRIS

- ❖ High quality and sensitivity vector magnetic fields measurement.
- ❖ Imaging spectro-polarimeter based on dual Fabry-Perot interferometer.
- ❖ Wavelength coverage: 1.0 – 1.75 μm (Fe I 1565 nm and He I 1083 nm).
- ❖ Field of view: 85" round.
- ❖ Cadence: ~ 40 s for a 40-positions sampling spectro-polarimetry.
- ❖ Polarimetry accuracy: 10 Gauss for longitudinal magnetic signals.
- ❖ Offer Stokes Inversion per request.
- ❖ Apply deep learning to Stokes Inversion.

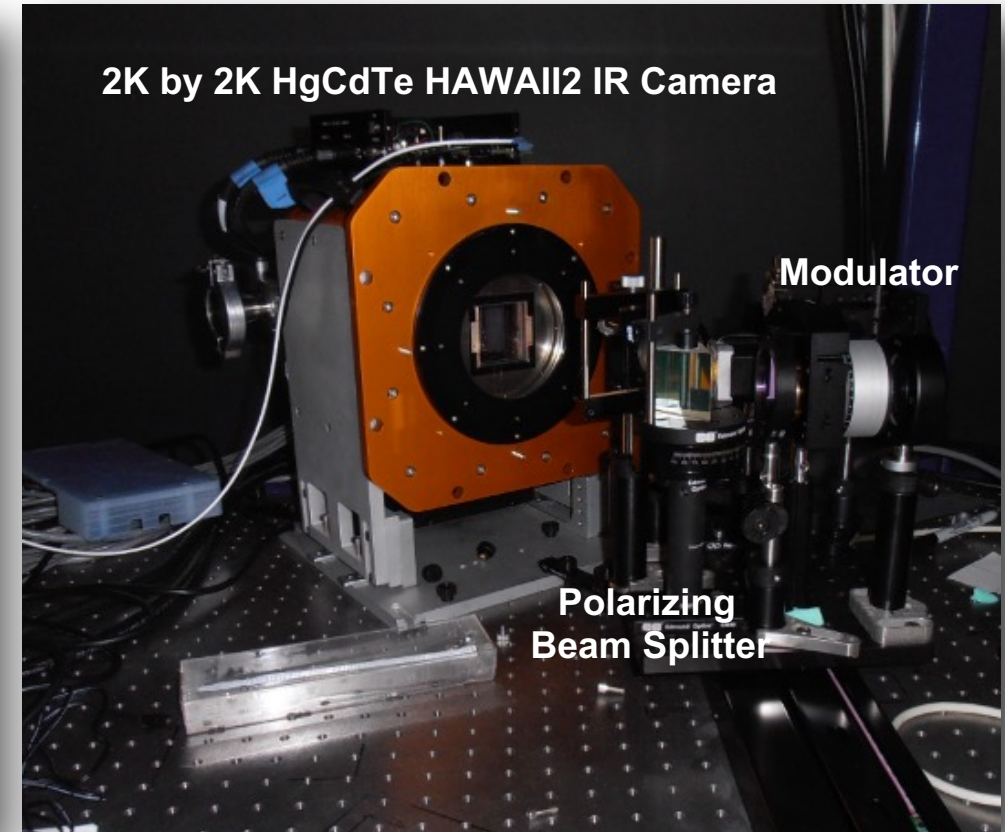
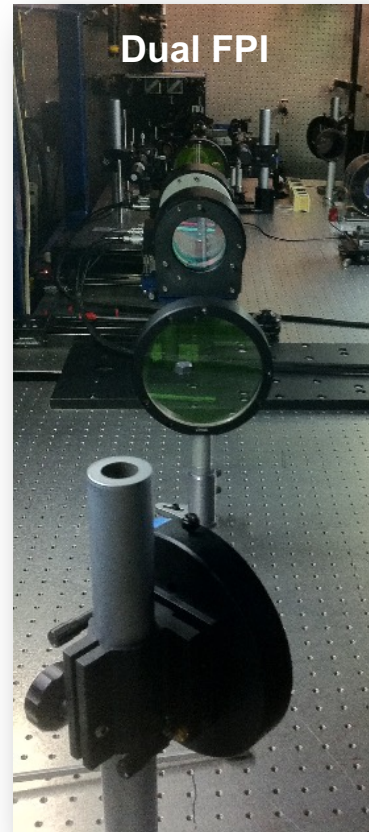

NIRIS Data Processing

- ❖ Dark/Flat Fielding.
- ❖ Align frames with features.
- ❖ Align dual beams.
- ❖ Subtract dual beams w/ de-stretch (registration).
- ❖ Combine 16 frames to create initial Stokes profiles.
- ❖ Correct for phase offset between modulator & detector.
- ❖ Calibrate instrumental crosstalk.
- ❖ Offer ME Stokes Inversion per request.
- ❖ Apply deep learning to Stokes Inversion.

$$(I' Q' U' V')^T = M (I Q U V)^T$$

$$M = M_n M_{n-1} M_{n-2} \dots M_3 T$$

$$(I Q U V)^T = M^{-1} (I' Q' U' V')^T$$

$$M(\text{dec}, \text{ha}) = M_{\text{rest}} R(\varphi_3, \text{ha}) M_4 R(\varphi_2, \text{dec}) M_3 R(\varphi_1)$$

$$M_{\text{rest}} = M [R(\varphi_3, \text{ha}) M_4 R(\varphi_2, \text{dec}) M_3 R(\varphi_1)]^{-1} = \text{constant}$$

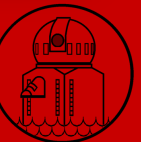
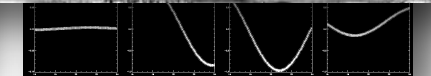
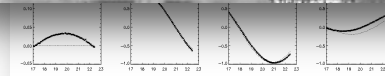
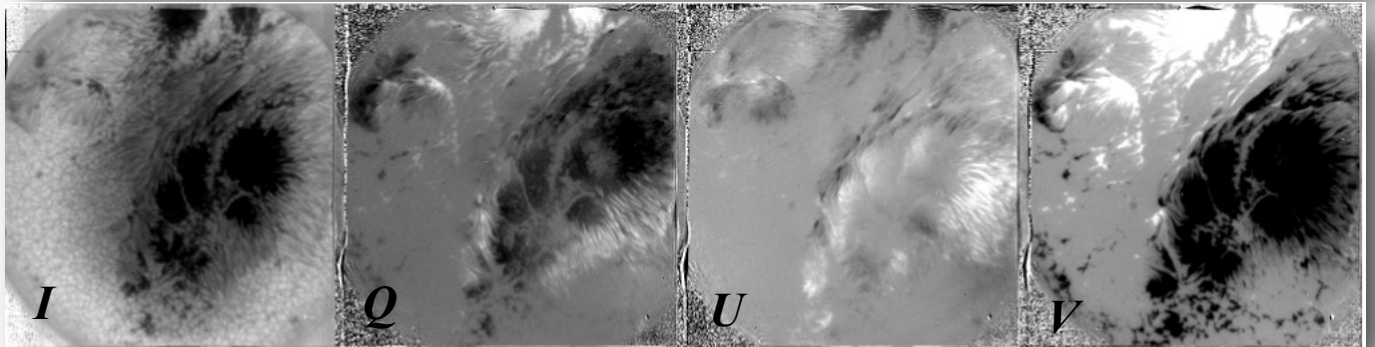
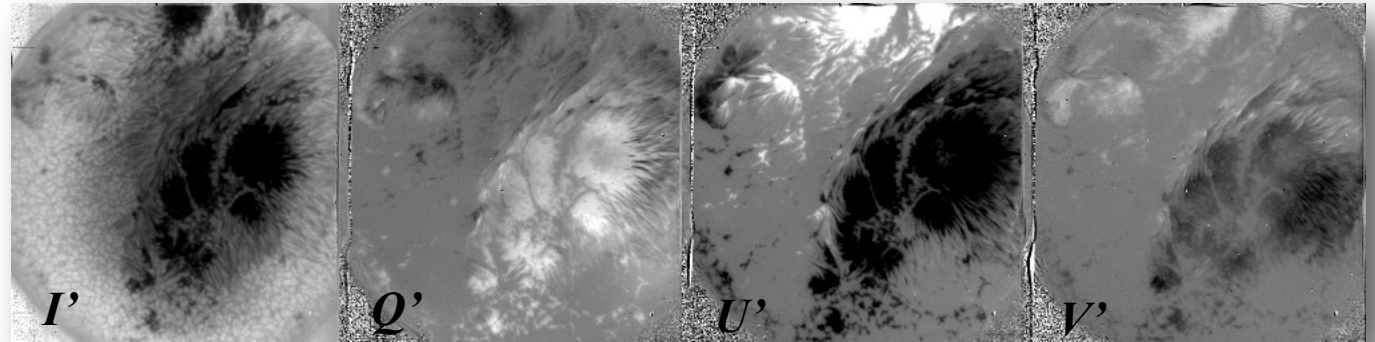
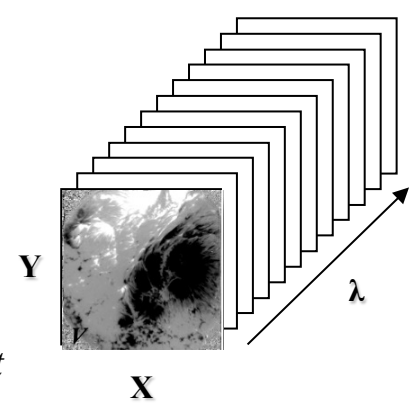

NIRIS, Hinode-SP and HMI

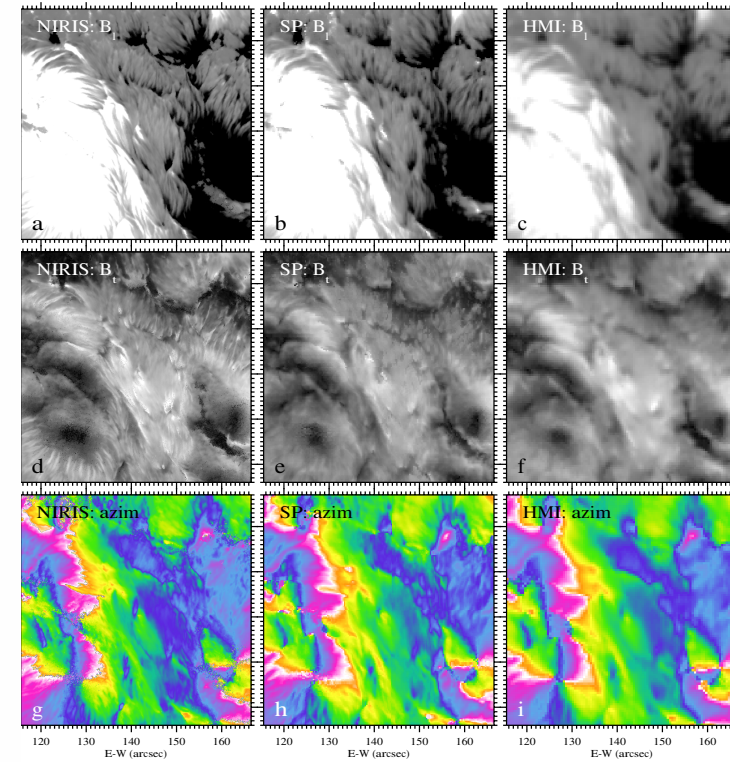
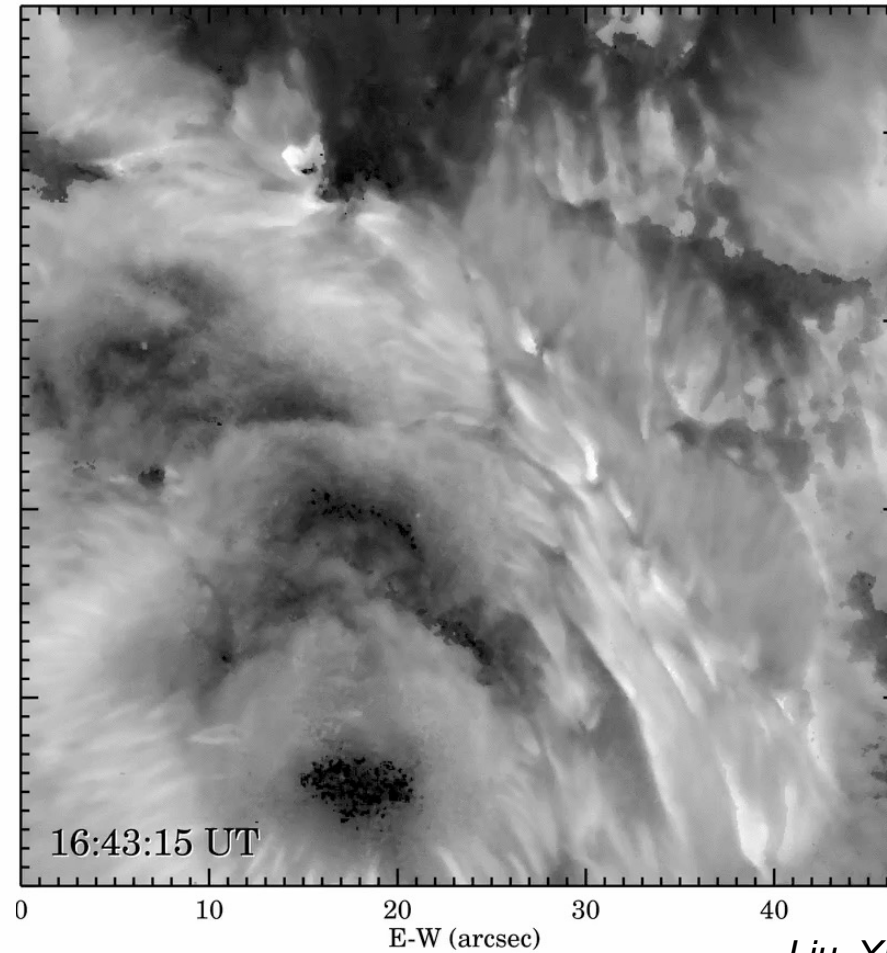
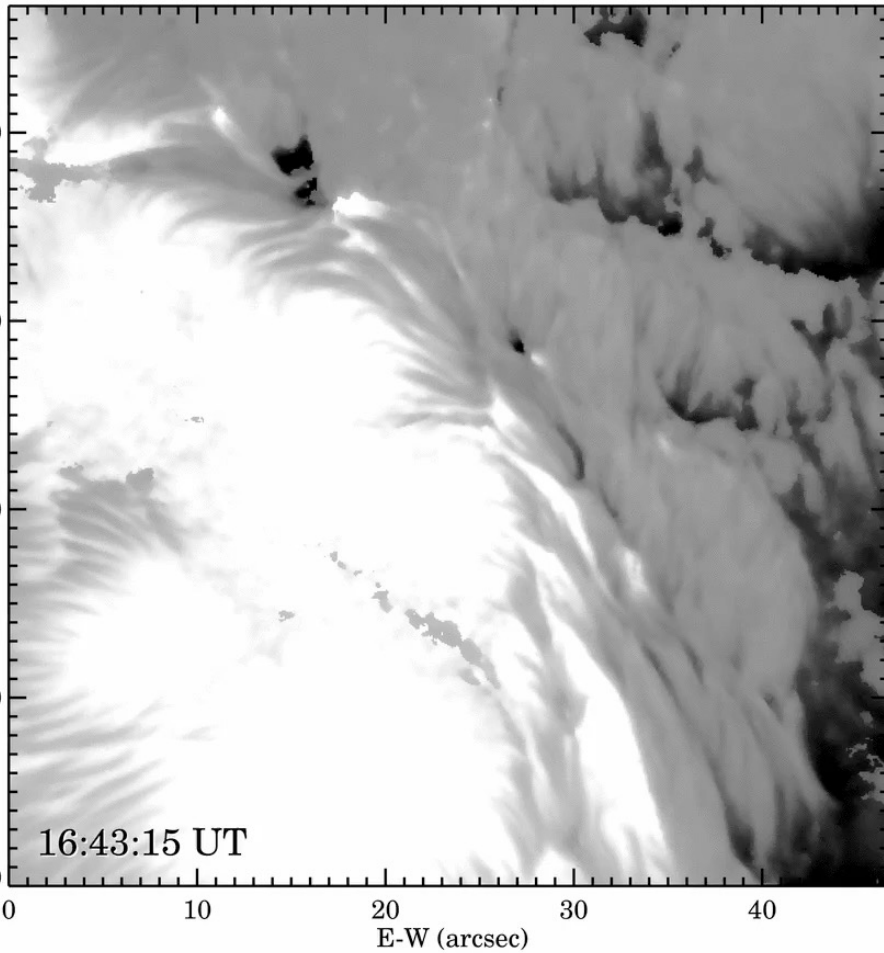

Liu, Xu, Cao, et al., Nature Communications, 2016

Fast Imaging Solar Spectrograph - FISS

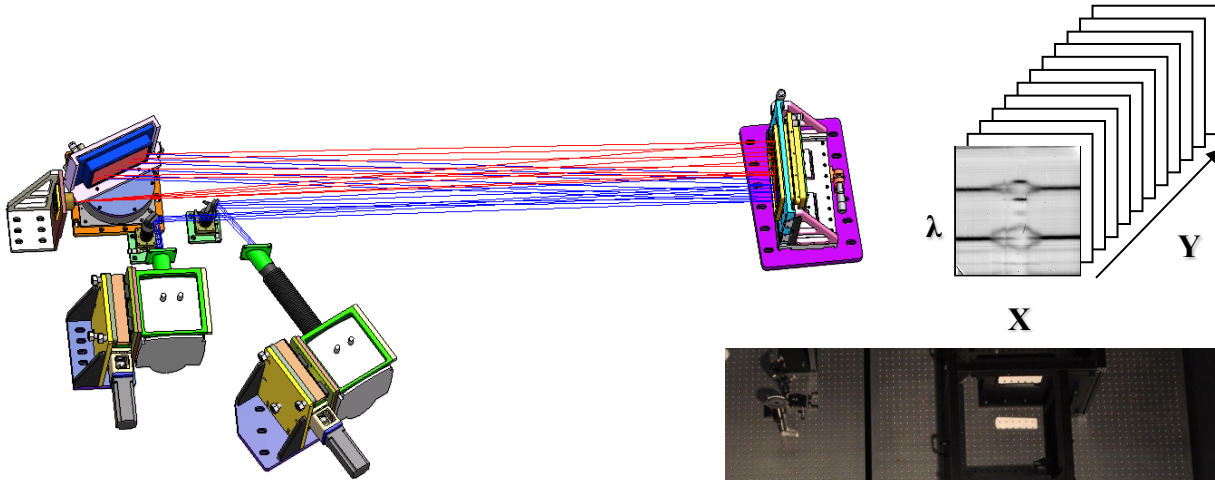

- High resolution imaging spectroscopy in solar atmosphere.
- Echelle grating with order-selecting filters in quasi-Littrow configuration.
- Slit-scan simultaneous imaging at dual-band spectra with two CCD cameras.
- Default setting: Ha & Ca II 854.2 nm.
- Field of view: 60" by 40".
- Spectral resolving power: $> 1.4 \times 10^5$.
- Cadence: < 60 s for a 60" by 40" scan.

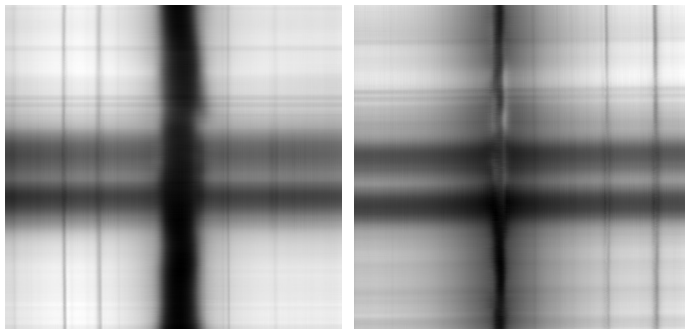

*Solar Physics, vol. 288, 2013.
"Initial Results from FISS"*

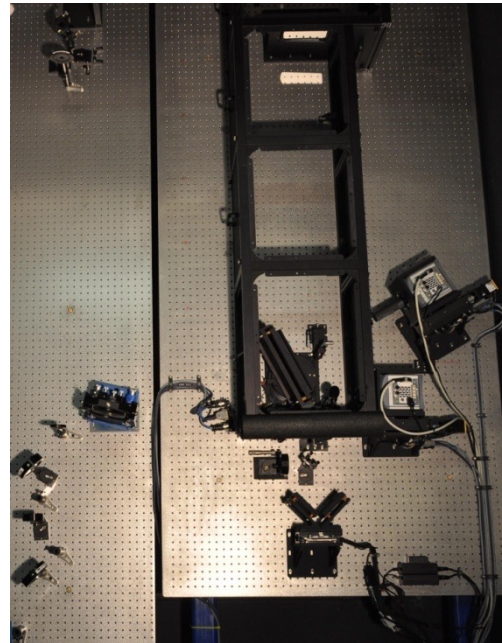



Upgrading Fast Imaging Solar Spectrograph - FISSP

- ❖ Upgrade FISS to be a spectropolarimeter FISSP.
- ❖ A slit assembly with an integrated context imager.
- ❖ A large-format spectrum camera for dual-beam polarimetry.
- ❖ An FLC-based polarimetric modulator and a polarimetric calibration unit.
- ❖ This setup is specifically designed to make use of an image restoration scheme developed for spectrograph data (van Noort 2017).
- ❖ FISSP can simultaneously measure dozens of unique spectral lines in a wide spectral range.

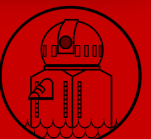
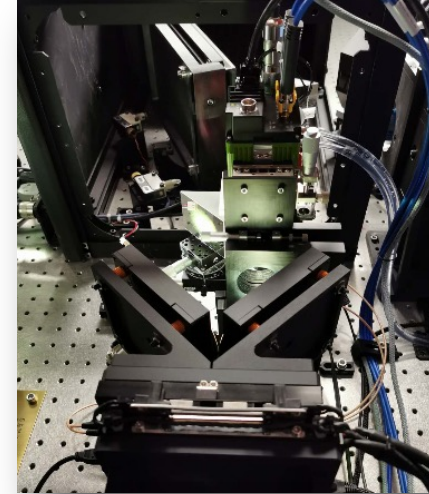



WHISPER

- ❖ US NSF-MRI: Development of Wide-band High-resolution Imaging Spectro-Polarimetric Explorer (*WHISPER*) for GST at BBSO.
- ❖ Joint project with BBSO, TSL MPS, SNU, KASI.
- ❖ 3-year project with 1 M\$ starting on 9/1/24.
- ❖ *WHISPER* spectral range: 516-526 nm.
- ❖ *WHISPER* employs an image reconstruction scheme developed for slit spectrographs to undo the effect of the residual seeing, optical aberrations and modulation transfer.
- ❖ *WHISPER* allows us to obtain diffraction-limited spectropolarimetry of 0".067 at 520 nm.

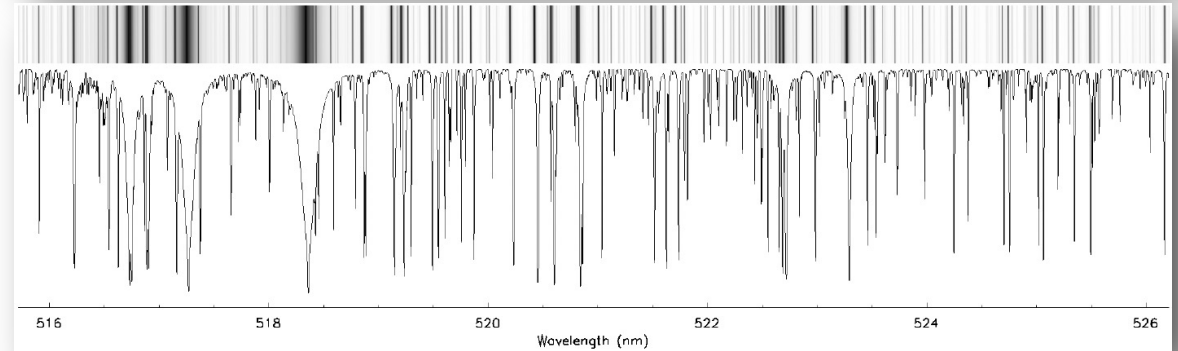
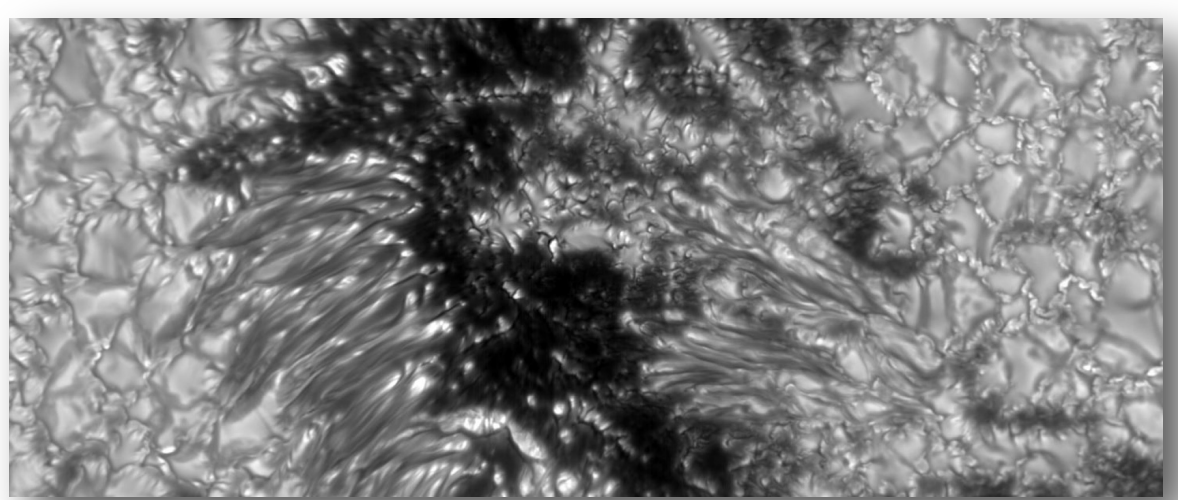

Parameter	Value
Wavelength coverage	500-650 nm (Goal: 460-650 nm)
Passband	10 nm @520nm
Resolving power	200,000 @520nm
Polarimeter	Dual-beam, liquid crystal modulator
Detectors	Sony IMX (Spectrum), GSPRINT4521 (Context)
FOV	60" × 60" (Goal: 70" × 70")

Cryogenic IR Spectrograph - CYRA

- ❖ Fully cryogenic IR solar spectrograph operating at 77 K to minimize background thermal emission
- ❖ Spectral range 1.0 to 5.0 μm with a FOV of 75"
- ❖ Spectral resolving power $> 10^5$
- ❖ High spatial resolution, high cadence spectrometry and polarimetry
- ❖ Image rotation compensator and image scanner
- ❖ Interest of IR spectral lines

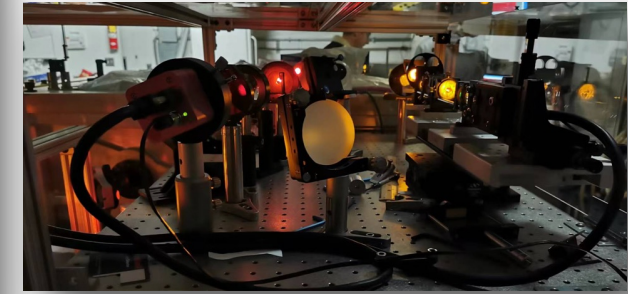
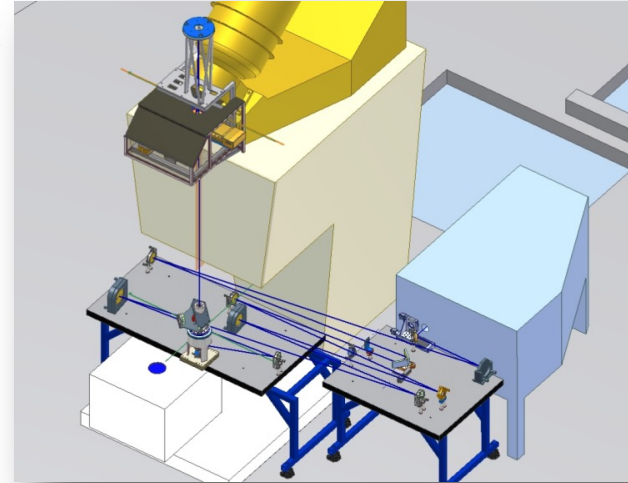
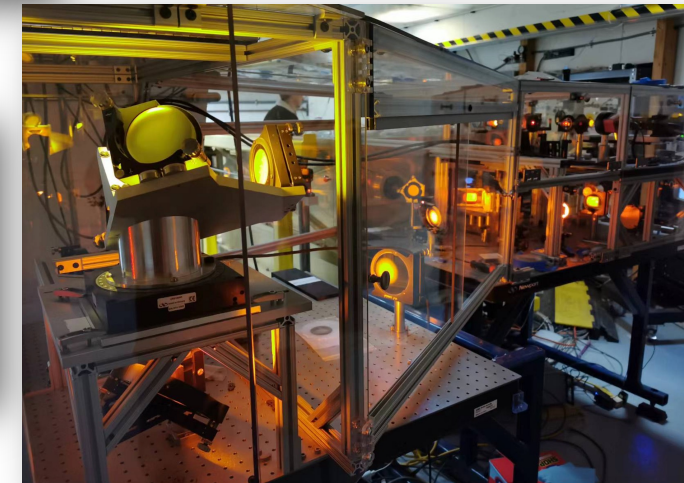
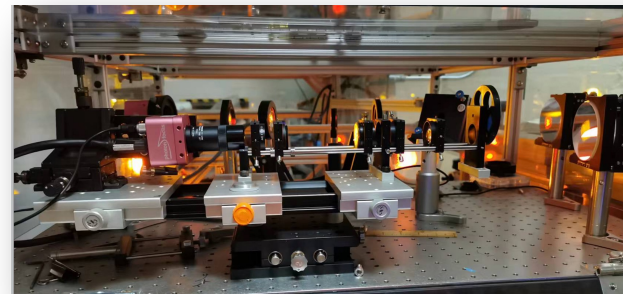
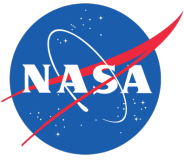

Table 1: Spectrograph Coverage of CYRA for Its Current Configuration

Region	Species	λ [nm]	$g\sigma$	Mag Sensitivity $\lambda_{g,\sigma}$ [nm]	Note
Photosphere	Fe I	1565	3	4695	Sunspot only
	Ti I	2231	2.5	5578	
	Fe I	4063.7	1.25	5080	
	Si I	4236.5	1.625 or 2.25	6732 or 9321	
Chromosphere	Ca I	3697.4	1.1	4067	Spectroscopic Spectroscopic
	Mg I	3681.6	1.17	4307	
	Fe I	4132	n/a	n/a	
	CO	4666	n/a	n/a	
Corona	Si X	3934	1.5	5901	



- ❖ Develop wavefront sensor and context imager



Mid-IR Imager - MIRI

- ❖ MIRI is a broad-band filter imager operating in Mid-IR, contributed by NASA/GSFC.
- ❖ QWIP is a two-color detector with 320×256 pixels, offering 20% of maximum response of $4.2\text{-}6.2 \mu\text{m}$ for $5 \mu\text{m}$ channel and $7.0\text{-}9.3 \mu\text{m}$ for the $8 \mu\text{m}$ channel.
- ❖ Typical exposure 10 ms and frame rate 15 fr/s.
- ❖ MIRI/GST provides diffraction limited imaging of $0.''67$ at $5.2 \mu\text{m}$ and $1.''06$ at $8.2 \mu\text{m}$, simultaneously.
- ❖ MIRI fills observational gap in Mid-IR spectral region of flare events, help us to understand the energy flow in the flare process.

BBSO_MIRI_B_20240222_222134

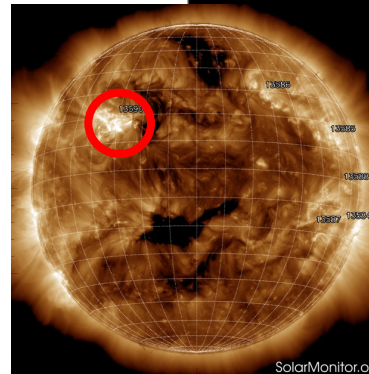
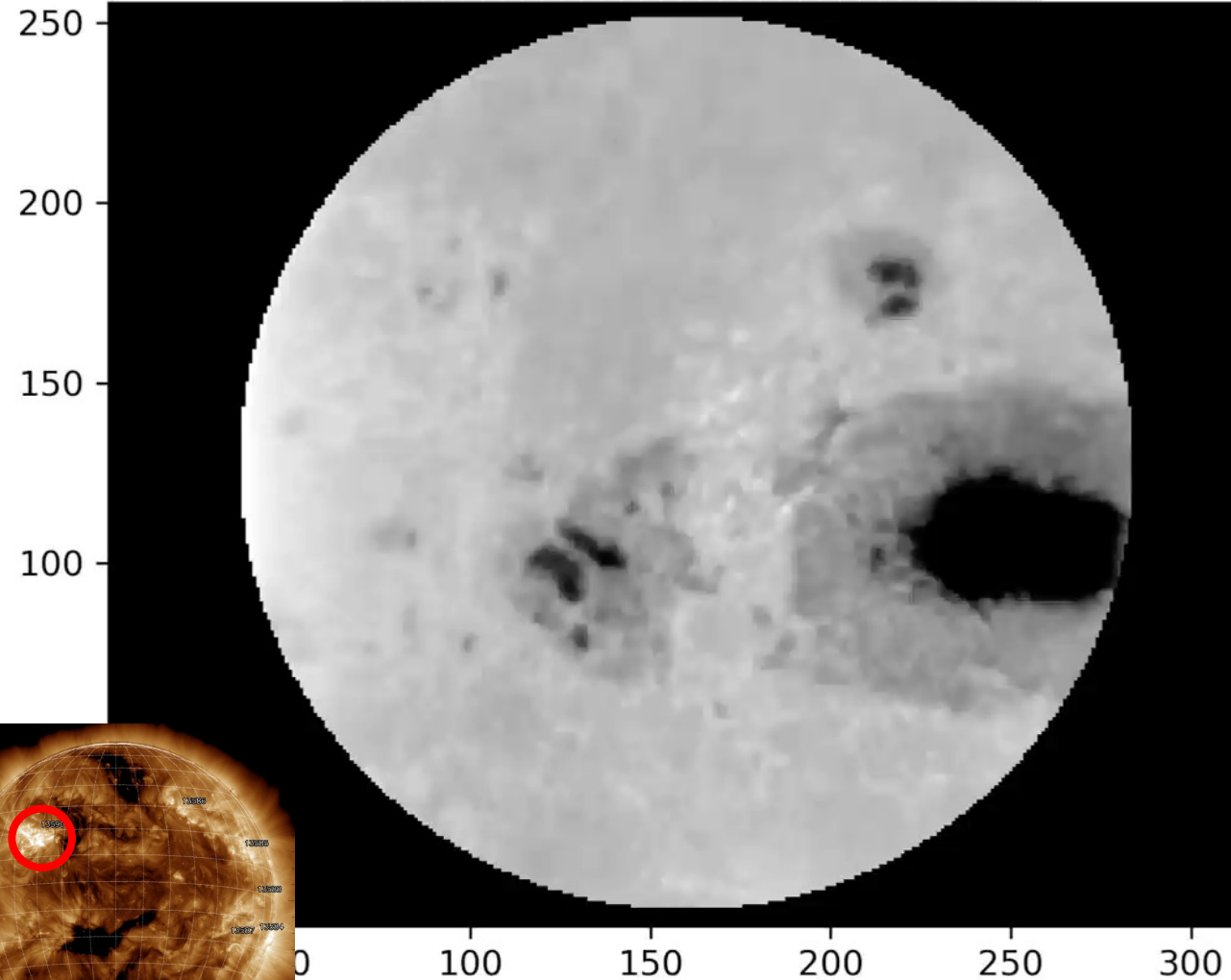

A X1.8 flare on 02/22/24 captured with MIRI $5 \mu\text{m}$ & $8 \mu\text{m}$

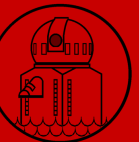



GST Data Pipeline and Mining

- VIS Spectroscopy and BFI Photometry Data:
 - Dark and flat fielding
 - Speckle reconstruction (Wöger, F.; von der Lühe, O.; Reardon, K., 2008)
- NIRIS Spectro-polarimetry Data:
 - Dark and flat fielding, polarization signals extraction
 - Telescope polarization calibration
 - Stokes inversion to offer physical parameter (B , v , T , azi) maps
- FISS spectroscopy Data:
 - Dark and flat fielding, correction of curvature, dust removal
 - Spectra calibration to generate temperature and velocity maps
- GST Data Mining:
 - Deep learning for NIRIS Stokes inversion
 - Scale-invariant feature transform and optical flow methods
 - GST image registrations with NASA space data (HMI, SDO ...)
 - High-precise co-alignment between all GST instruments

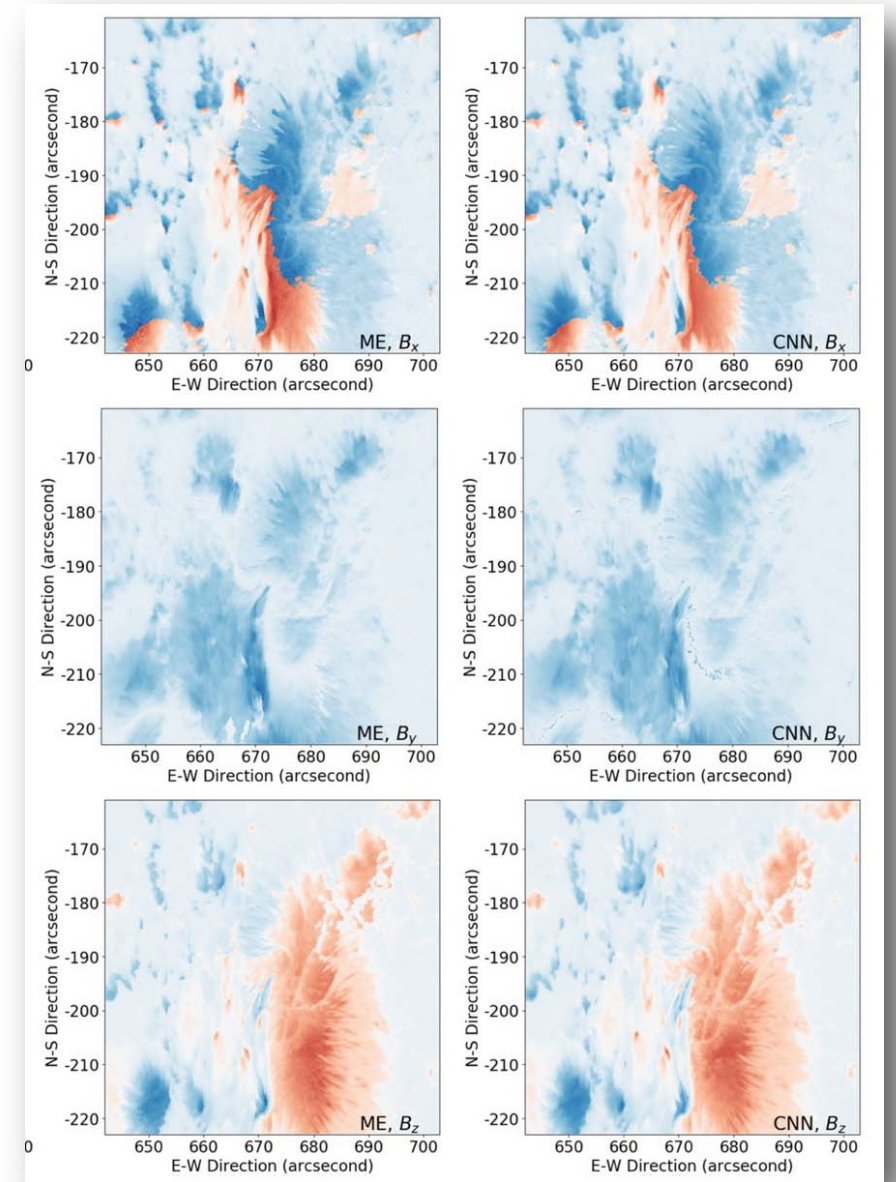

Hao et al., ApJ 894, 70, 2020



Synoptic Program at BBSO



BBSO Supports NASA Missions

- ❖ *Skylab – the First US Space Station – NASA*
- ❖ *Spacelab – a Reusable Space Laboratory - ESA & NASA*
- ❖ *Yohkoh – “Solar-A” - JAXA & NASA*
- ❖ *SOHO – Solar and Heliospheric Observatory - ESA & NASA*
- ❖ *TRACE – Transition Region and Coronal Explorer – NASA*
- ❖ *SDO – Solar Dynamics Observatory – NASA*
- ❖ *Hinode – “Solar-B” – JAXA & NASA*
- ❖ *IRIS – Interface Region Imaging Spectrograph – NASA*
- ❖ *NuSTAR – Nuclear Spectroscopic Telescope Array – NASA*
- ❖ *RHESSI – Reuven Ramaty High Energy Solar Spectroscopic Imager – NASA*
- ❖ *Hi-C II – High Resolution Coronal Imager Rocket Mission – NASA*
- ❖ *CLASP-2 – Chromospheric Layer Spectropolarimeter Rocket Mission – NASA*
- ❖ *PSP – Parker Solar Probe – NASA*
- ❖ *SO – Solar Orbiter – ESA & NASA*
- ❖ *BITSE & CODEX – KASI & NASA*
- ❖ *EUVST – “Solar-C” - JAXA & NASA*

Table 1: NASA PSP Mission Support with GST in 2019, 2020, 2021, 2022, 2023 and 2024

Encounter	Perihelion Date	PSP-GST Campaign Duration	GST Instruments	Completed Tasks
#18	12/11/2023	12/15/2023 - 01/12/2024 (29 days)	BFI, VIS/FISS, NIRIS	NASA PSP Mission Support with GST in Phase II
#17	09/27/2023	09/18/2023 - 10/08/2023 (21 days)	BFI, VIS/FISS, NIRIS	
#16	06/22/2023	06/13/2023 - 07/02/2023 (20 days)	BFI, VIS/FISS, NIRIS	
#15	03/17/2023	03/03/2023 - 03/31/2023 (29 days)	BFI, VIS/FISS, NIRIS	
#14	12/11/2022	11/28/2022 - 12/23/2022 (26 days)	BFI, VIS/FISS, NIRIS	
#13	09/06/2022	08/27/2022 - 09/16/2022 (21 days)	BFI, VIS/FISS, NIRIS	
#12	06/01/2022	05/23/2022 - 06/12/2022 (20 days)	BFI, VIS/FISS, NIRIS	
#11	02/25/2022	02/14/2022 - 03/06/2022 (21 days)	BFI, VIS/FISS, NIRIS	
#10	11/21/2021	11/15/2021 - 11/26/2021 (12 days)	BFI, VIS/FISS, NIRIS	NASA PSP Mission Support with GST in Phase I
#9	08/09/2021	08/01/2021 - 08/15/2021 (15 days)	BFI, VIS/FISS, NIRIS	
#8	04/29/2021	04/22/2021 - 05/06/2021 (14 days)	BFI, VIS/FISS, NIRIS	
#7	01/17/2021	01/04/2021 - 02/14/2021 (42 days)	BFI, VIS/FISS, NIRIS	
#6	09/27/2020	08/28/2020 - 10/27/2020 (61 days)	BFI, VIS/FISS, NIRIS	
#5	06/07/2020	05/08/2020 - 07/07/2020 (61 days)	BFI, VIS/FISS, NIRIS	
#4	01/29/2020	12/25/2019 - 02/28/2020 (66 days)	BFI, VIS/FISS, NIRIS	

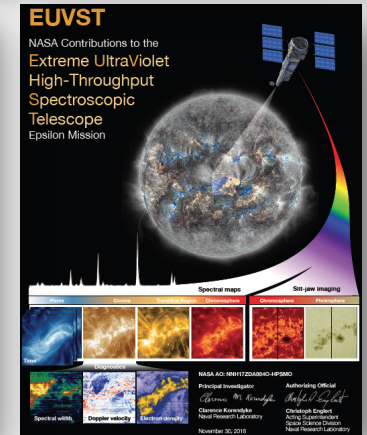
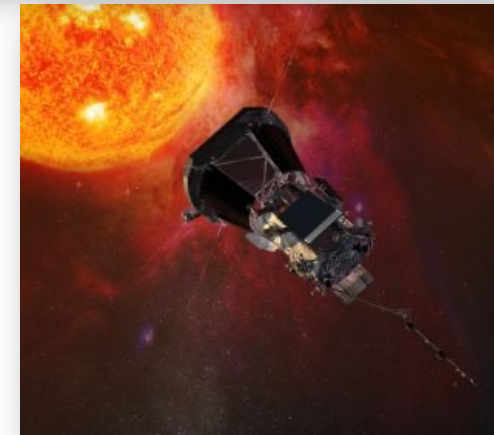

GST Time and Data Opening to Community

- ❖ BBSO TAC has approved 78 PI-driven observing proposals covering 1,028 observing days in past three years. Test service mode with 30 observing proposals in AY21.
- ❖ 56.1% (AY18), 75.0% (AY19), 82.6% (AY20) and 80.0% (AY21) of GST observing time allocated to external users.
- ❖ GST observing proposals deadline on March 31 for premium observing season (Apr. 15 – Oct. 30).

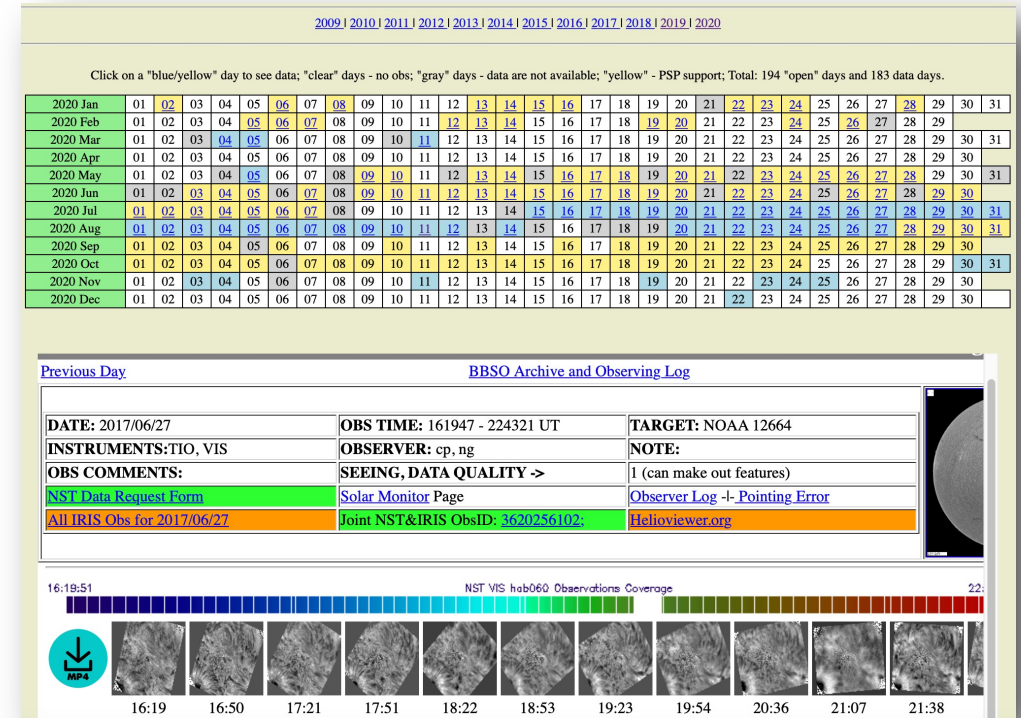

- **Submit observing proposal:** <http://www.bbso.njit.edu/cgi-bin/GSTObsForm>
- **GST data download request:** http://www.bbso.njit.edu/~vayur/NST_catalog/
- **GST data browse:** http://www.bbso.njit.edu/~vayur/gst_logs/



- *Instituto de Astrofisica de Canarias – IAC, Spain*
- *Universidad de La Laguna, Department of Astrophysics, Spain*
- *Seoul National University – SNU, Korea*
- *Korea Astronomy and Space Science Institute – KASI, Korea*
- *Indian Institute of Astrophysics – IIA, India*
- *Indian Institute of Technology – IIT BHU, India*
- *University of Sydney – USYD, Australia*
- *University of Graz – IGAM, Austria*
- *University of Oslo – RoCS, Norway*
- *Observatoire de Paris – LESIA, France*
- *Institut d'Astrophysique Spatiale - IAS, France*
- *Tel Aviv University, Israel*
- *National Solar Observatory of Japan – NAOJ, Japan*
- *Japan Aerospace Exploration Agency – ISAS, Japan*
- *Nagoya University – STEL, Japan*
- *Nanjing University – NJU, China*
- *Peking University – PKU, China*
- *University of Science and Technology of China – USTC, China*
- *National Astronomical Observatory of China – NAOC, China*
- *University of Warwick – Center for Fusion Space and Astrophysics, UK*
- *Northumbria University – NU, UK*
- *University of Glasgow – SUPA, Scotland*
- *University of St Andrews – RCSP & ITA, Scotland*



NJIT

New Jersey Institute of Technology

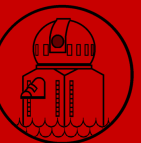

High Impact of GST Research

- ❖ 250+ peer-reviewed publications from GST observations since 2010, mostly in top journals, like *Nature*, *Science*, *ApJ*, *A&A*, *MNRAS*, *ApJS*, and *ApJL*, etc.
- ❖ Significant discoveries in the fields of *quiet Sun*, *sunspot oscillations*, *structure of sunspots and pores*, *Ellerman bombs*, *small-scale reconnection*, *chromosphere flows*, *filaments and prominence*, *solar flares*, *corona heating*, etc.
- ❖ One *Science* and six *Nature* journal papers.
- ❖ 80+ PhD Students graduated/working on their thesis with GST data.

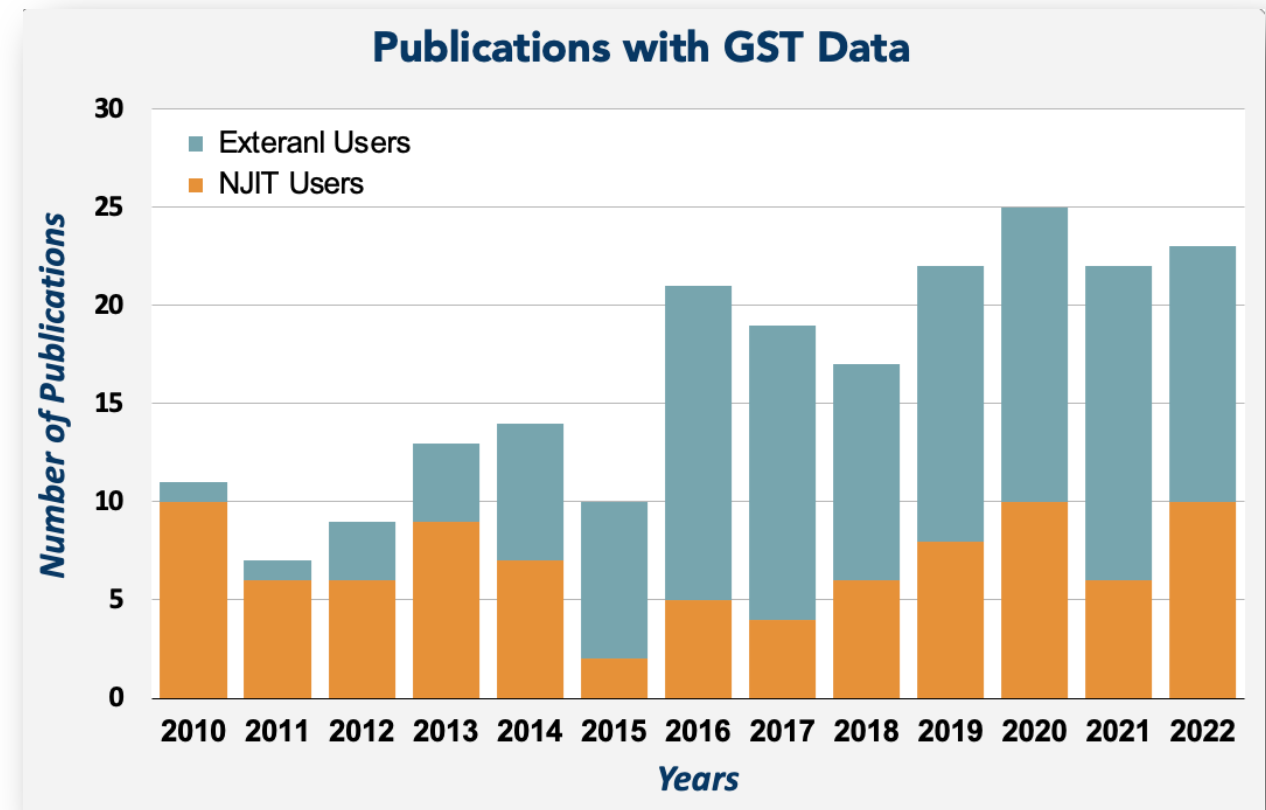

https://ui.adsabs.harvard.edu/public-libraries/IBI9h5Y7TXWdf_A4CCKCMA



We gratefully acknowledge the use of data from the Goode Solar Telescope (GST) of the Big Bear Solar Observatory (BBSO). BBSO operation is supported by US NSF AGS-2309939 grant and New Jersey Institute of Technology. GST operation is partly supported by the Korea Astronomy and Space Science Institute and the Seoul National University.